



## INO-Series

### Mix & Match

Ιταλικού/ Γερμανικού τύπου



## H-Series

### Sockets & switches

Γερμανικού τύπου



## S-Series

### Surface mounted IP20

Πρίζες & διακόπτες



# INO Series

**Mix and match as you like**  
Ανακατέψτε και ταιριάξτε όπως θέλετε

LINEME INO-Series meets the specific aesthetic demands, either at work or living space. Lean and modern design suitable for residential, office, hotel and commercial buildings.

Decorative frames for wall sockets and switches. The frames can be easily combined with electrical sockets and switches in different colors from the same serie.

Η σειρά LINEME INO ανταποκρίνεται σε συγκεκριμένες αισθητικές απαιτήσεις, είτε στον χώρο εργασίας είτε στο χώρο διαμονής. Λιτός και μοντέρνος σχεδιασμός κατάλληλος για κατοικίες, γραφεία, ξενοδοχεία και εμπορικά κτίρια. Διακοσμητικά πλαίσια για πρίζες τείχους και διακόπτες. Τα πλαίσια μπορούν εύκολα να συνδυαστούν με ηλεκτρικές πρίζες και διακόπτες σε διαφορετικά χρώματα από την ίδια σειρά.



switch your life

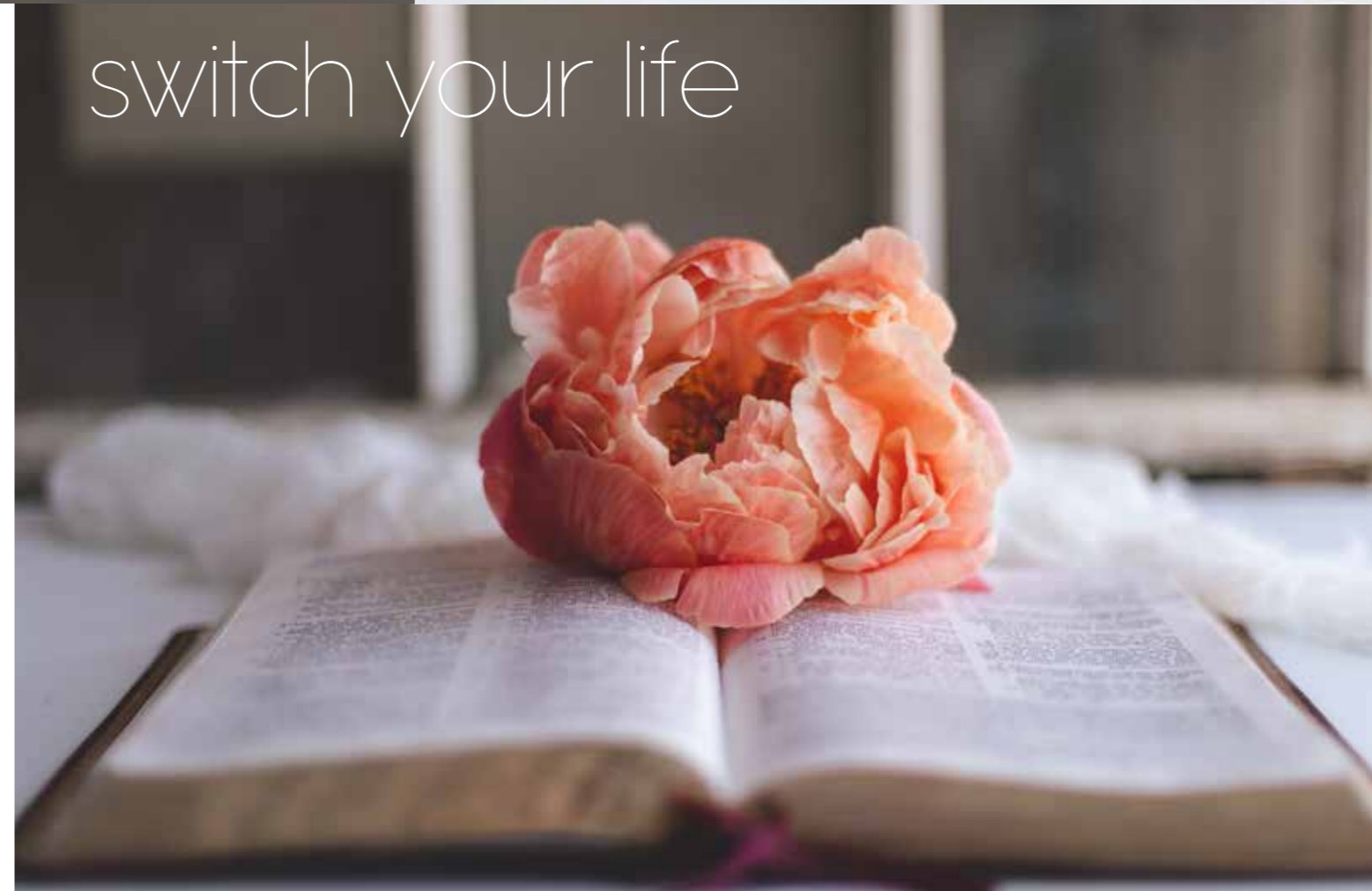

INO

## Mix & match, the perfect match

Ανακατέψτε & ταιριάξτε, ο τέλειος συνδυασμός

For all the **LINEME products**, are used premium quality materials so that they meet all the safety requirements. The metal parts are manufactured of specially treated, fine quality metal, to achieve the maximum stability on the mounting surface. All the sockets mechanisms are equipped with protective copper power outlets, a double-holding system, normal hardness protective grounding clips and screw-tighten copper power supply terminals. All switch mechanisms have the option of being illuminated using a lamp.

Στα προϊόντα διακοπτικού υλικού **LINEME**, χρησιμοποιούνται υλικά άριστης ποιότητας, έτσι ώστε να πληρούν όλες τις προδιαγραφές ασφαλείας. Τα μεταλλικά μέρη είναι κατασκευασμένα από ειδικά κατεργασμένο μέταλλο υψηλής αντοχής, για απόλυτη στιβαρότητα και μεγάλη ανθεκτικότητα. Όλοι οι εξαιρετικής ποιότητας μηχανισμοί, διαθέτουν χάλκινες προστατευμένες επαφές ασφαλείας, διπλό σύστημα συγκράτησης, ελάσματα γείωσης ιδανικής σκληρότητας και χάλκινες βιδωτές επαφές παροχής ρεύματος. Όλοι οι μηχανισμοί διακοπών έχουν τη δυνατότητα να γίνουν φωτιζόμενοι χρησιμοποιώντας λυχνία.

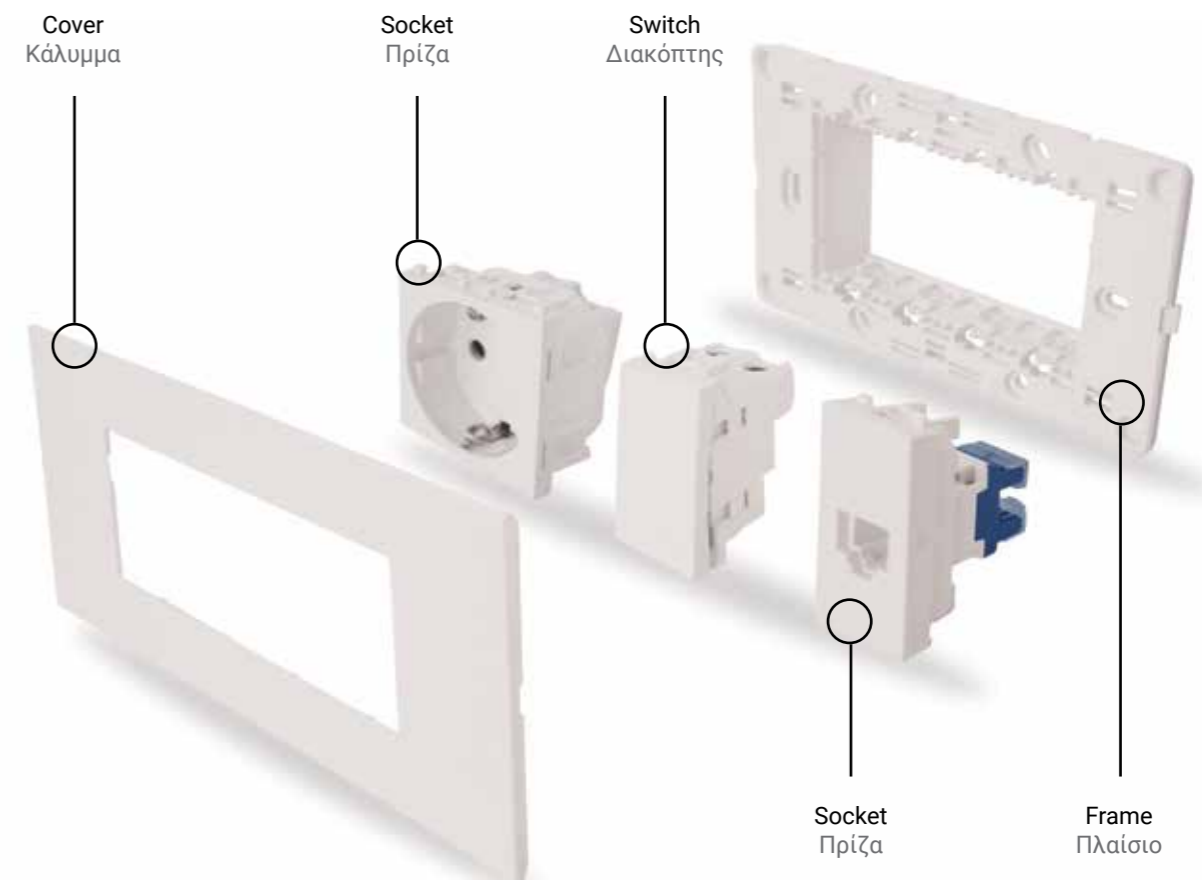

## Variety of functions Ποικιλία λειτουργιών

LINEME INO-Series switching, provides a range of switches and sockets, for all the functions you can find in a residential or a professional environment.

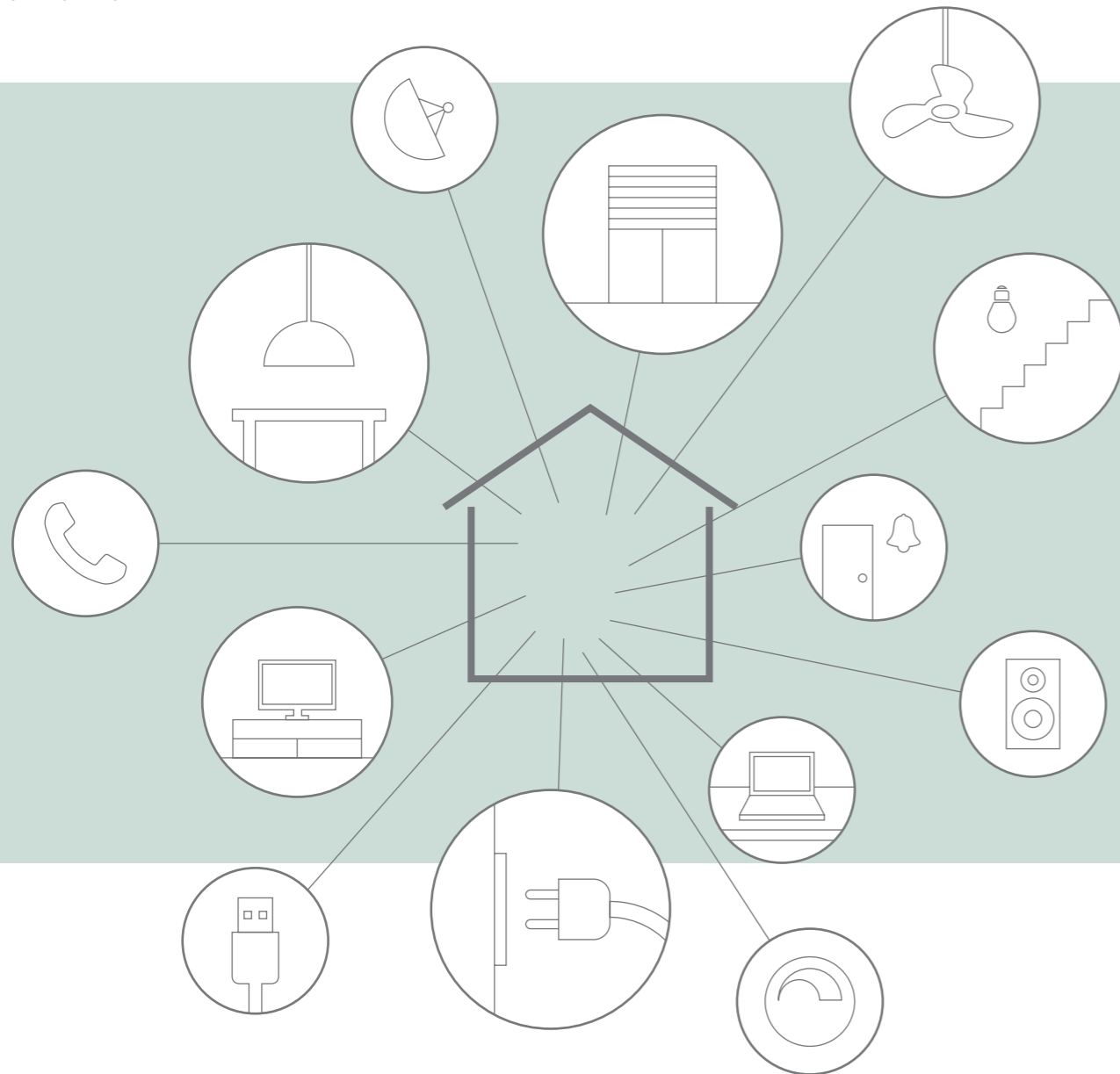

Η σειρά διακοπτικού υλικού LINEME INO, διαθέτει μία γκάμα διακοπών και πριζών, για όλες τις λειτουργίες που μπορείτε να βρείτε, σε ένα σπίτι και σε έναν επαγγελματικό χώρο.



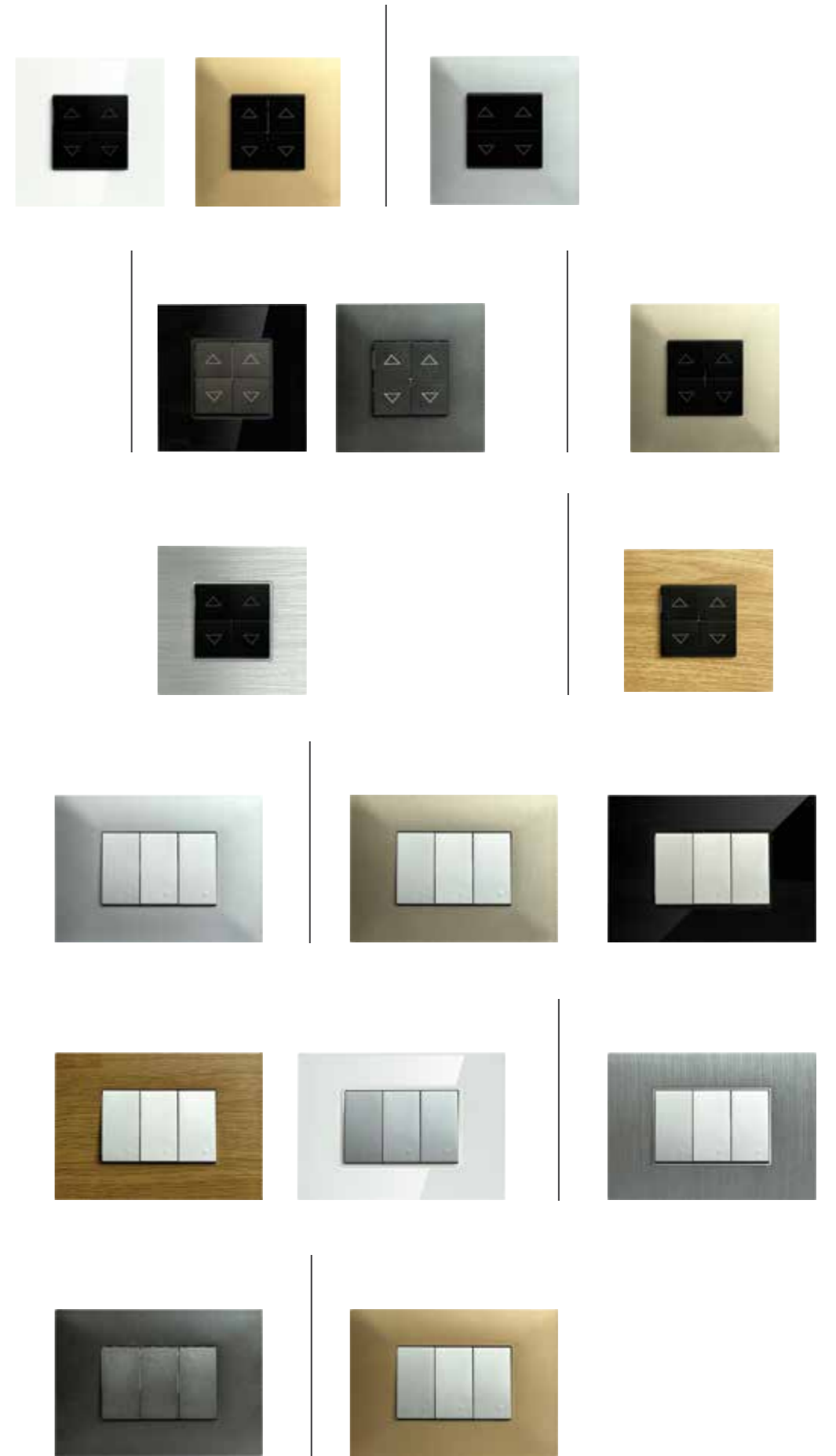

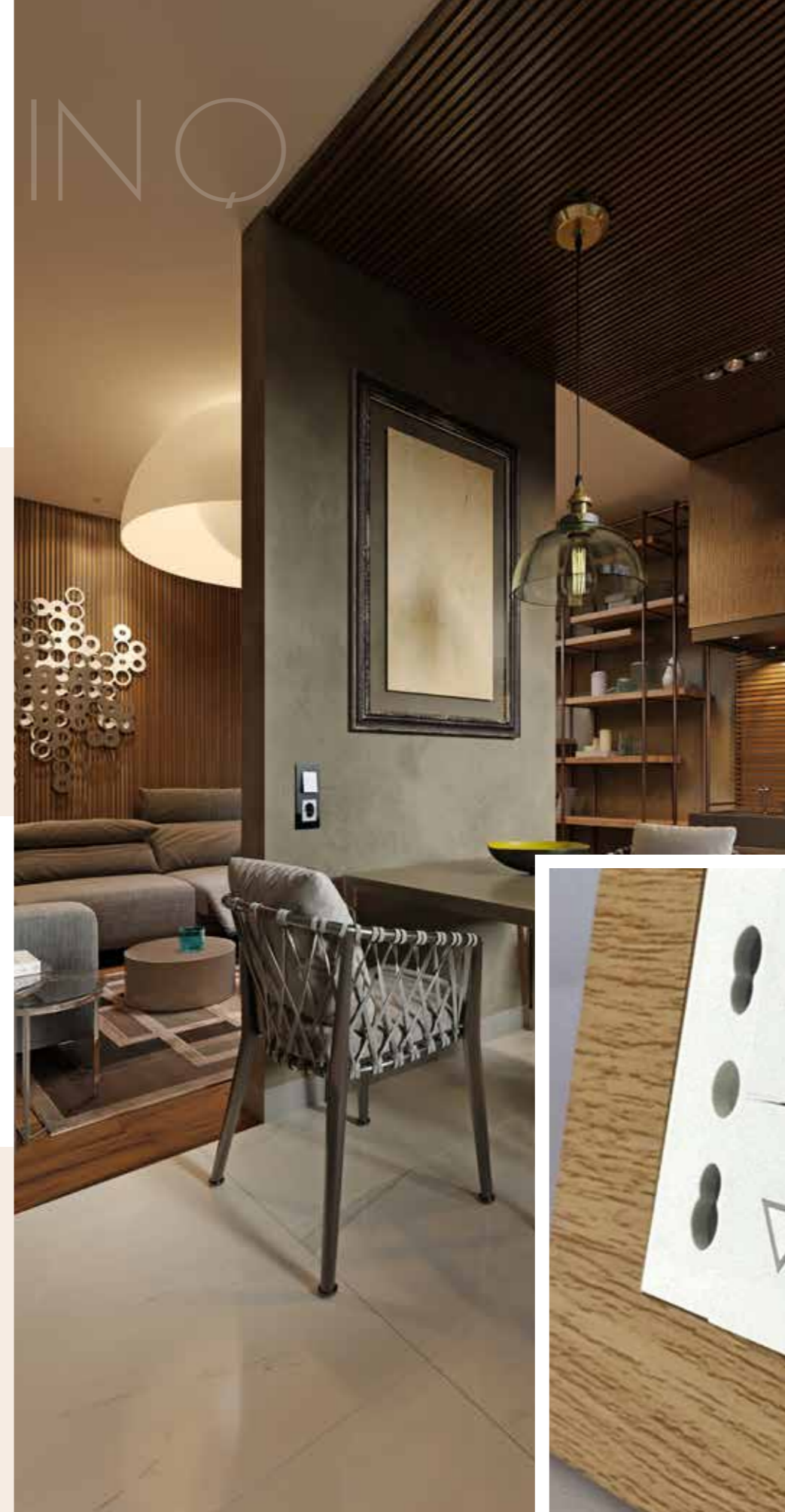

wall decoration

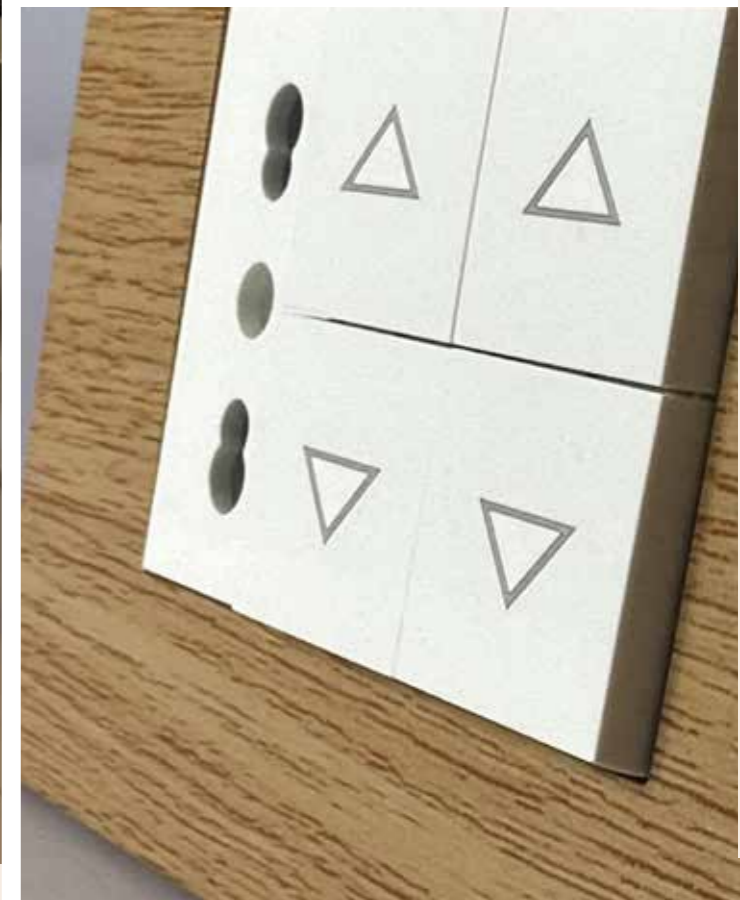

## Lighting switches Διακόπτες φωτισμού

## Lighting switches Διακόπτες φωτισμού

### One-way switch Διακόπτης απλός



1M/10A  
Βάθος: 30mm  
Διάσταση: 22mmx44mm

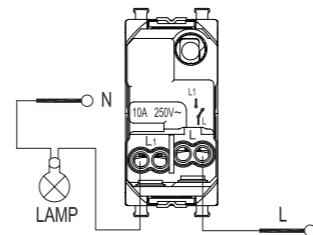

2M/10A  
Βάθος: 30mm  
Διάσταση: 44mmx44mm



1M/10A  
Βάθος: 30mm  
Διάσταση: 22mmx44mm

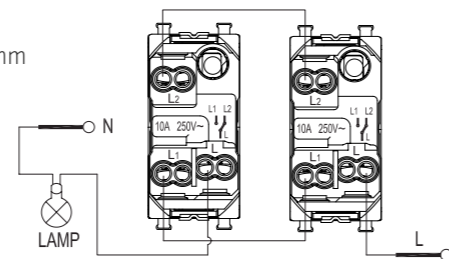

1M/10A  
Βάθος: 30mm  
Διάσταση: 44mmx44mm

### Intermediate switch Διακόπτης μεσαίος αλέρετου



1M/10A  
Βάθος: 30mm  
Διάσταση: 22mmx44mm

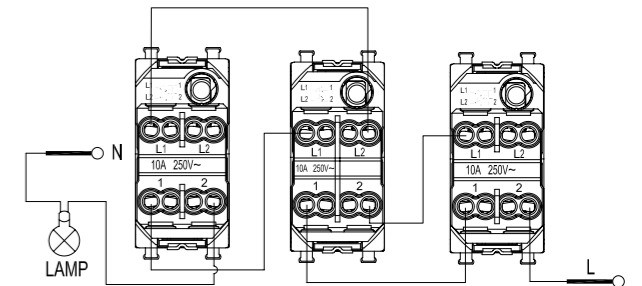

2M/10A  
Βάθος: 30mm  
Διάσταση: 44mmx44mm

### Two-way switch Διακόπτης αλέρετου

### Double pole switch Διακόπτης διπολικός



1M/10A  
Βάθος: 30mm  
Διάσταση: 22mmx44mm

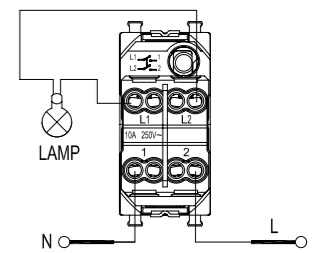

2M/10A  
Βάθος: 30mm  
Διάσταση: 44mmx44mm

## Push button Μπουτόν

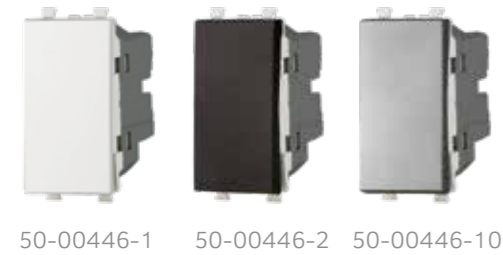

1M/10A  
Βάθος: 30mm  
Διάσταση: 22mmx44mm



2M/10A  
Βάθος: 30mm  
Διάσταση: 44mmx44mm

### Push button Μπουτόν

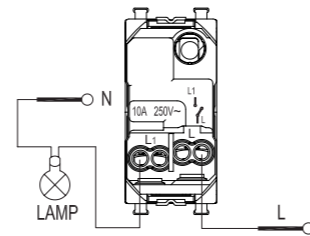

## Covers Πλακίδια

### Covers Πλακίδια



Κάλυμμα θέσης (τάπα) 1M  
Cover1M

Διάσταση: 22mmx44mm

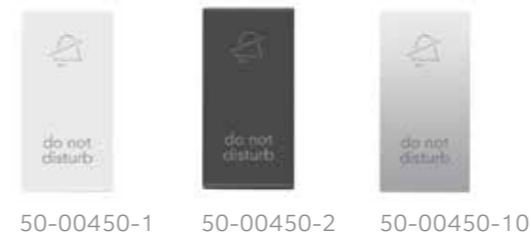

Ανταλλάξιμο πλακίδιο "Do not disturb" 1M  
Front cover "Do not disturb" 1M

Διάσταση: 22mmx44mm



Ανταλλάξιμο πλακίδιο "Please clean" 1M  
Front cover "Please clean" 1M

Διάσταση: 22mmx44mm

### Pull cord button Μπουτόν τραβηχτό

**ΑΝΑΜΕΝΕΤΑΙ**



1M  
Βάθος: 30mm  
Διάσταση: 22mmx44mm

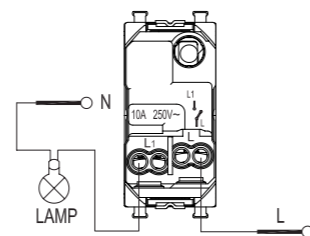

## Curtain switch Διακόπτης ρολλών



1M/10A  
Βάθος: 30mm  
Διάσταση: 22mmx44mm

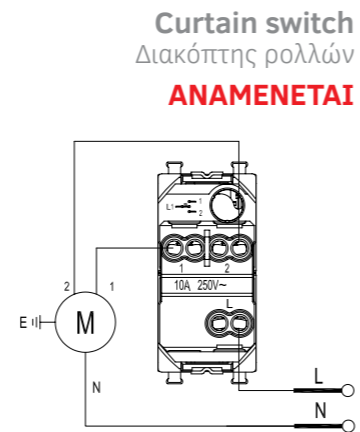

simple things  
made beautiful

## Curtain button Μπουτόν ρολλών



1M/10A  
Βάθος: 30mm  
Διάσταση: 22mmx44mm

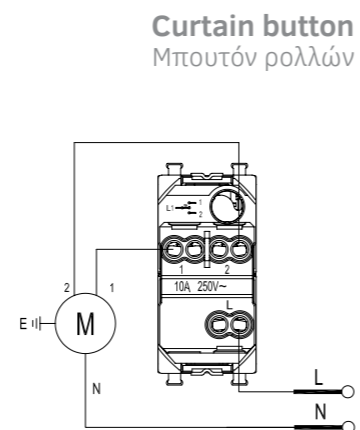

## Push button Μπουτόν



Μπουτόν με ένδειξη "κωδώνου" 2M  
με δυνατότητα τοποθέτησης λυχνίας  
Door bell push button 2M  
option for lamp installation  
  
Βάθος: 30mm  
Διάσταση: 44mmx44mm

### Door bell push button Μπουτόν με ένδειξη κωδώνου

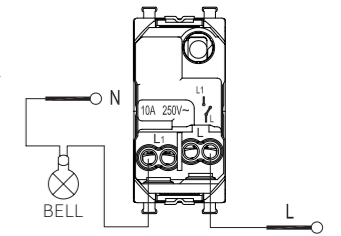

Μπουτόν με επιγραφή 2M  
με δυνατότητα τοποθέτησης λυχνίας  
Push button with name plate 2M  
option for lamp installation  
  
Βάθος: 30mm  
Διάσταση: 44mmx44mm  
Διασταση επιγραφής: 42mmx12mm

### Push button with name plate Μπουτόν με επιγραφή

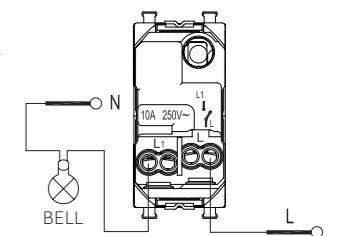

Μπουτόν με ένδειξη "φως" 2M/10A  
με δυνατότητα τοποθέτησης λυχνίας  
Stairway push button 2M/10A  
option for lamp installation  
  
Βάθος: 30mm  
Διάσταση: 44mmx44mm

### Stairway push button Μπουτόν με ένδειξη φως

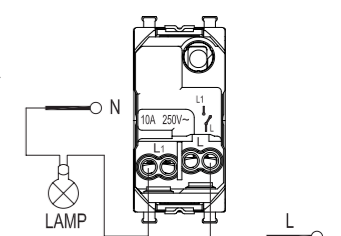

## Dimmers Ρεοστάτες

### Dimmer A/R for ordinary light Ρεοστάτης A/R για απλό λαμπτήρα



400Wmax 1M  
Βάθος: 43mm  
Διάσταση: 22mmx44mm

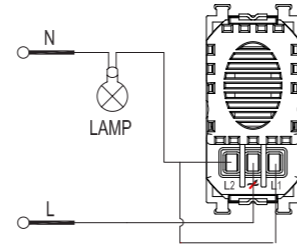

50-00410-1 50-00410-2 50-00410-10

### Dimmer A/R for LED light Ρεοστάτης A/R για λαμπτήρα LED



200Wmax 1M  
Βάθος: 43mm  
Διάσταση: 22mmx44mm

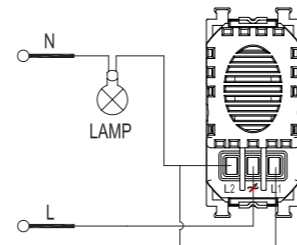

50-00411-1 50-00411-2 50-00411-10

### Fan dimmer Ρεοστάτης ανεμιστήρα



300VA 1M  
Βάθος: 43mm  
Διάσταση: 22mmx44mm

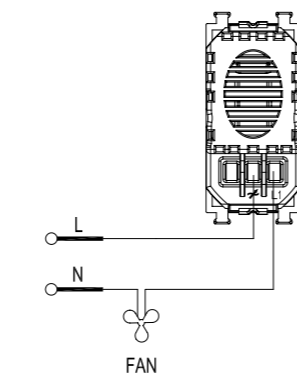

50-00412-1 50-00412-2 50-00412-10

## Emergency light Φωτιστικό ασφαλείας

### Emergency LED light Φωτιστικό ασφαλείας LED **ANAMENETAI**



50-43456-1 50-43456-2 50-43456-10

3M 120-230V  
50-60Hz  
Βάθος: 35mm  
Διάσταση: 66.3mmx44mm

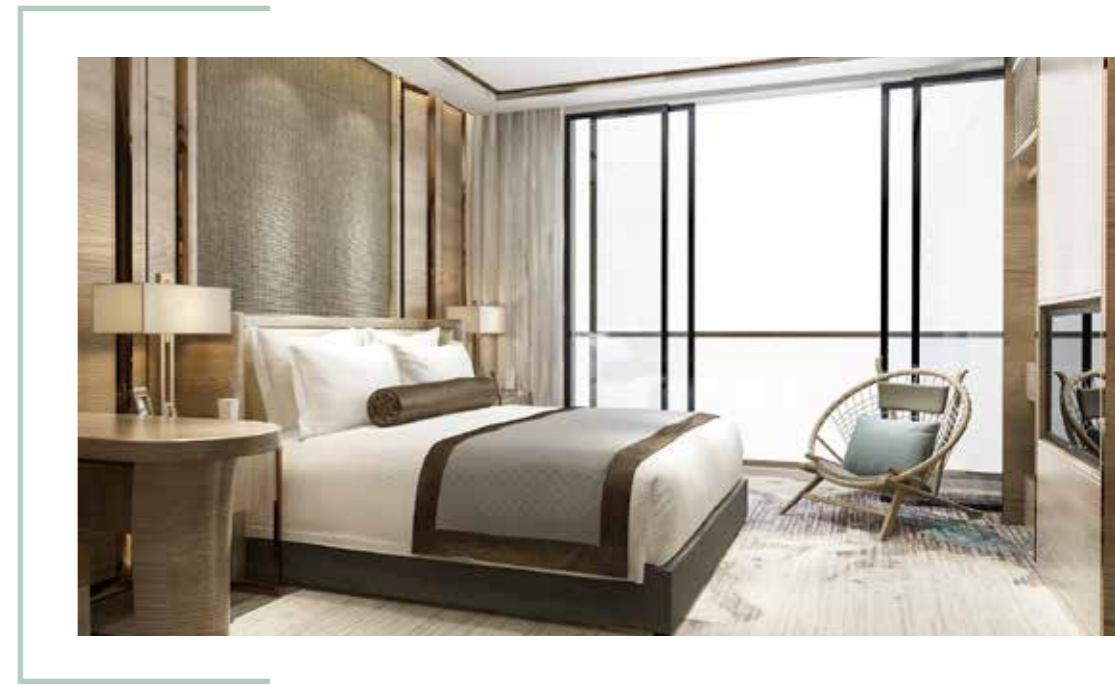
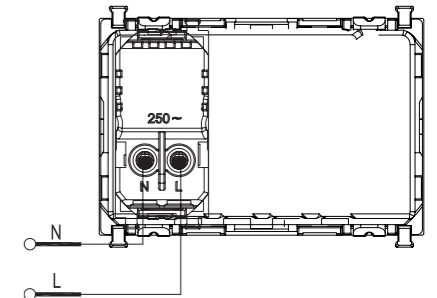

## LED Lights

Ενδεικτικές λυχνίες LED

### LED night light 3000K

Ενδεικτική λυχνία LED 3000K



50-30443-1 50-30443-2 50-30443-10

1M 3000K  
Βάθος: 38mm  
Διάσταση: 22mmx44mm

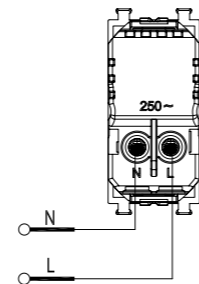

### LED night light Red

Ενδεικτική λυχνία LED κόκκινη  
**ANAMENETAI**



50-14443-1 50-14443-2 50-14443-10

1M  
30" καθυστέρηση στο σβήσιμο  
Βάθος: 38mm  
Διάσταση: 22mmx44mm

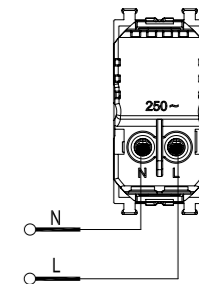

### LED night light 6000K

Ενδεικτική λυχνία LED 6000K



50-60443-1 50-60443-2 50-60443-10

1M 6000K  
Βάθος: 38mm  
Διάσταση: 22mmx44mm

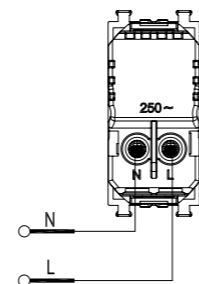

### Κάλυμμα για φωτάκι νυκτός

Night light cover  
**ANAMENETAI**



50-00455 50-00456

1M  
Διάσταση: 22mmx30mm

### LED night light Green

Ενδεικτική λυχνία LED πράσινη  
**ANAMENETAI**



50-13443-1 50-13443-2 50-13443-10

1M  
30" καθυστέρηση στο σβήσιμο  
Βάθος: 38mm  
Διάσταση: 22mmx44mm

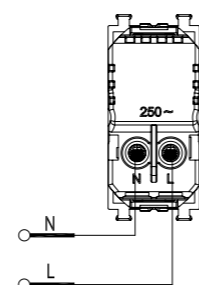

### LED indicator component warm 220-240V

Ενδεικτικό λαμπάκι LED θερμό 220-240V



50-00900

Warm white  
220-240V  
Μήκος: 33mm Ø70mm  
Καλώδιο: 7cm

## Card reader switch Καρτοδιακόπτης



50-00440-1      50-00440-2      50-00440-10

3M 4A 250V  
Βάθος: 35mm  
Διάσταση: 66.3mmx44mm

### Card reader switch Καρτοδιακόπτης

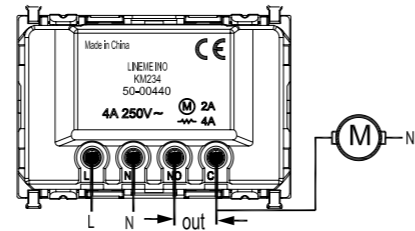

50-03455-1      50-03455-2      50-03455-10

3M 4A 250V  
Βάθος: 35mm  
Διάσταση: 66.3mmx44mm

## Card reader switch Καρτοδιακόπτης

### Card reader switch MIFARE Καρτοδιακόπτης MIFARE **ANAMENETAI**



50-00930      50-00931

Κάρτα PVC  
PVC Card  
Διάσταση:  
55mmx85mm

Κάρτα PVC εκτυπωμένη  
PVC Printed Card  
Διάσταση:  
55mmx85mm

### Card Κάρτα



50-00932      50-00933

Κάρτα MIFARE  
MIFARE Card  
Διάσταση:  
55mmx85mm

Κάρτα MIFARE εκτυπωμένη  
Mifare printed Card  
Διάσταση:  
55mmx85mm

### Card Κάρτα **ANAMENETAI**

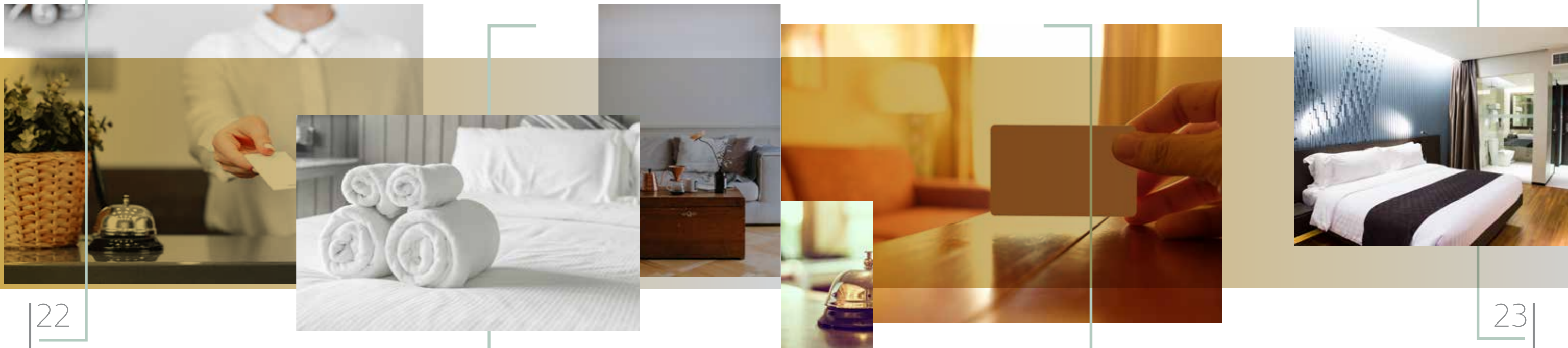

## Sockets Πρίζες

## Sockets Πρίζες



50-00413-1 50-00413-2 50-00413-10

2M 16A 250V  
Βάθος: 35mm  
Διάσταση: 44mmx44mm

### Schuko socket Πρίζα σούκο ασφαλείας

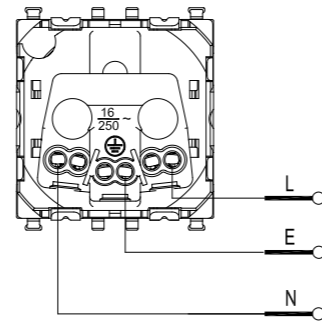

50-00444-1 50-00444-2 50-00444-10

1M 16A  
Βάθος: 30mm  
Διάσταση: 22mmx44mm

### Italian socket Πρίζα ευθείας ασφαλείας

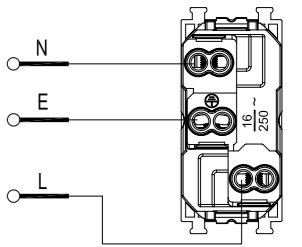

50-00413-14

2M 16A 250V  
Βάθος: 35mm  
Διάσταση: 44mmx44mm

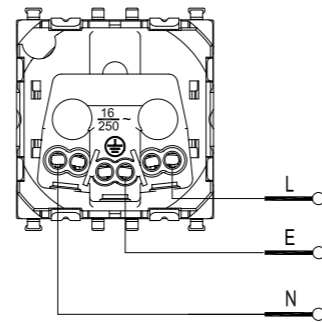

### USB socket Πρίζα USB

Πρίζα USB typeA & typeC 2M **TAXEIA ΦΟΡΤΙΣΗ**  
USB typeA & typeC 2M **FAST CHARGING**

Βάθος: 40mm  
Διάσταση: 44mmx44mm

QC3.0 output voltage: 5V/9V/12V  
QC3.0 output current: 3.4A/2.3A/1.5A  
PD output voltage: 5V/9V/12V  
PD output current: 3.4A/2.3A/1.5A

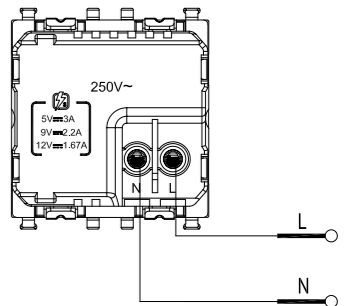

50-02439-1 50-02439-2 50-02439-10

### Schuko socket with cap Πρίζα σούκο ασφαλείας με καπάκι



50-00414-1 50-00414-2 50-00414-10

2M 16A 250V  
Βάθος: 35mm  
Διάσταση: 44mmx44mm

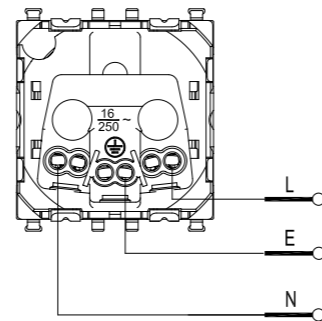

50-00439-1 50-00439-2 50-00439-10

Πρίζα USB typeA & typeC 1M  
5,1V/2,4A 250V **ΚΑΝΟΝΙΚΗ ΦΟΡΤΙΣΗ**  
USB typeA & typeC 1M  
5,1V/2,4A 250V **NORMAL CHARGING**

Βάθος: 40mm  
Διάσταση: 22mmx44mm

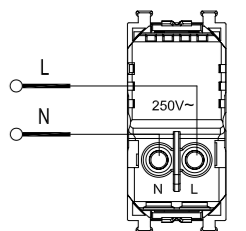

## Sockets Πρίζες

## Sockets Πρίζες

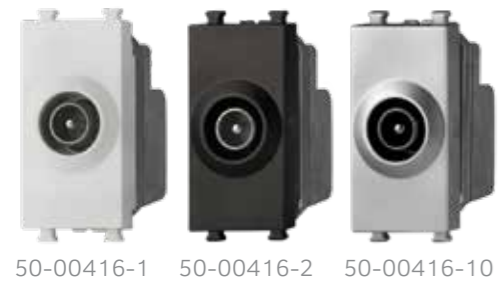

1M  
Απορρόφηση κατανομής 1dB  
Βάθος: 27mm  
Διάσταση: 22mmx44mm

**TV socket**  
Πρίζα τηλεόρασης τερματική

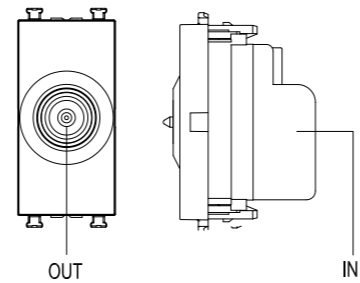

1M  
Διάσταση: 22mmx44mm

**Cover for RJ45**  
Πλακίδιο για μηχανισμό RJ45



1M  
Απορρόφηση κατανομής 10dB  
Βάθος: 27mm  
Διάσταση: 22mmx44mm

**Intermediate TV socket**  
Πρίζα τηλεόρασης διελεύσεως

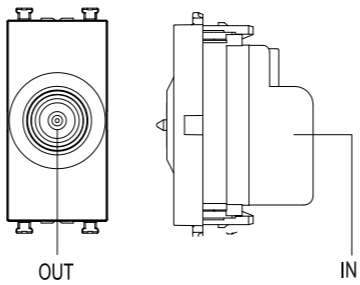

Data CAT7  
Keystone κούμπωμα  
Βάθος: 38mm

**Data CAT7**  
Μηχανισμός data CAT7

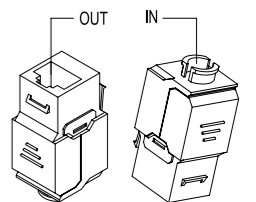

1M  
Απορρόφηση κατανομής 10dB  
Βάθος: 27mm  
Διάσταση: 22mmx44mm

**SAT socket**  
Πρίζα δορυφορική τερματική

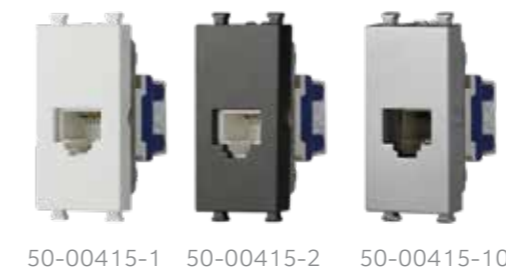
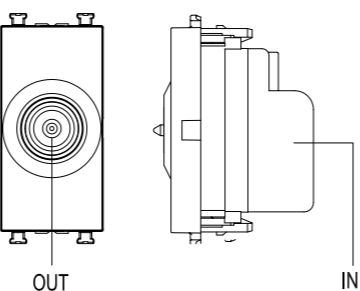

1M  
Βάθος: 33mm  
Διάσταση: 22mmx44mm

**RJ11 telephone socket**  
Πρίζα RJ11 τηλεφώνου

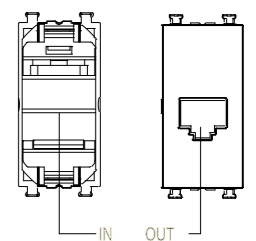

## Sockets Πρίζες



**HDMI socket**  
Πρίζα HDMI

1M 4K

Βάθος: 45mm  
Διάσταση: 22mmx44mm

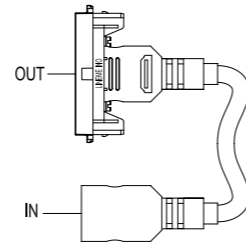

**Loud speaker socket**  
Πρίζα ηχείων

1M  
Βάθος: 25mm  
Διάσταση: 22mmx44mm

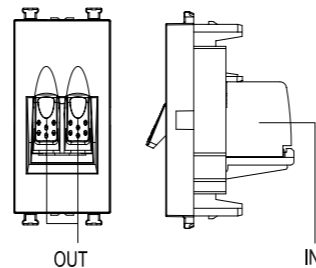

## Rectangular boxes for brick wall Ορθογώνια κουτιά τοίχου

3M box  
Κουτί  
3 θέσεων



50-00903

106x74x65mm

4M box  
Κουτί  
4 θέσεων



50-00904

131x74x65mm

7M box  
Κουτί  
7 θέσεων



50-00907

191x78x65mm

## Rectangular boxes for hollow wall Ορθογώνια κουτιά γυψοσανίδας

3M box  
Κουτί  
3 θέσεων



50-01903

112x68x50mm

4M box  
Κουτί  
4 θέσεων



50-01904

133x68x50mm

7M box  
Κουτί  
7 θέσεων



50-01907

188x68x50mm

## PVC support frames Στήριγματα PVC

1M  
support  
frame  
Στήριγμα  
1 θέσης

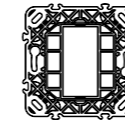

**ANAMENETAI**

50-01401

- περιλαμβάνει άγκιστρα
- κατάλληλο για τοποθέτηση σε κυτίο τοίχου ή γυψοσανίδας

2M  
support  
frame  
Στήριγμα  
2 θέσεων



50-01400-1

- περιλαμβάνει άγκιστρα
- κατάλληλο για τοποθέτηση σε κυτίο τοίχου ή γυψοσανίδας

3M  
support  
frame  
3 θέσεων



50-01400-3

- περιλαμβάνει άγκιστρα
- κατάλληλο για τοποθέτηση σε κυτίο τοίχου ή γυψοσανίδας

4M  
support  
frame  
Στήριγμα  
4 θέσεων

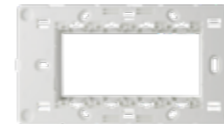

50-01400-4

- περιλαμβάνει άγκιστρα
- κατάλληλο για τοποθέτηση σε κυτίο τοίχου ή γυψοσανίδας

7M  
support  
frame  
Στήριγμα  
7 θέσεων



















50-01400-7

- περιλαμβάνει άγκιστρα
- κατάλληλο για τοποθέτηση σε κυτίο τοίχου ή γυψοσανίδας

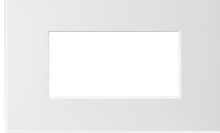

## Multiple frames PVC Πλαίσια πολλαπλών θέσεων PVC

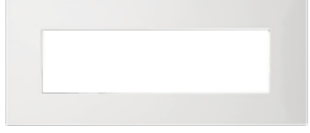
Πάχος: 7mm

Color Χρώμα	 <b>White</b> Λευκό	 <b>Black</b> Μαύρο	 <b>Silver</b> Ασημί	Basic
1M frame πλαίσιο 1 θέσης	 50-00420-1	 50-00420-2	 50-00420-10	
2M frame πλαίσιο 2 θέσεων	 50-00421-1	 50-00421-2	 50-00421-10	
3M frame πλαίσιο 3 θέσεων	 50-00423-1	 50-00423-2	 50-00423-10	
4M frame πλαίσιο 4 θέσεων	 50-00424-1	 50-00424-2	 50-00424-10	
7M frame πλαίσιο 7 θέσεων	 50-00427-1	 50-00427-2	 50-00427-10	

## Multiple frames PVC Πλαίσια πολλαπλών θέσεων PVC

Color Χρώμα	 <b>Wood</b> Φυσικό δρυς	 <b>Champagne</b> Σαμπανιζέ	 <b>Gold matte</b> Χρυσό ματ	Elegant
1M frame πλαίσιο 1 θέσης	 50-00420-27	 50-00420-28	 50-00420-9	
2M frame πλαίσιο 2 θέσεων	 50-00421-27	 50-00421-28	 50-00421-9	
3M frame πλαίσιο 3 θέσεων	 50-00423-27	 50-00423-28	 50-00423-9	
4M frame πλαίσιο 4 θέσεων	 50-00424-27	 50-00424-28	 50-00424-9	
7M frame πλαίσιο 7 θέσεων	 50-00427-27	 50-00427-28	 50-00427-9	



## Multigang frames glass & aluminum Πλαίσια γυάλινα & αλουμινίου

Πάχος: 9mm

Color Χρώμα	 <b>White</b> Λευκό	 <b>Black</b> Μαύρο	 <b>Silver</b> Ασημί
2M frame Πλαίσιο 2 θέσεων	 50-00421-23	 50-00421-26	 50-00421-18
3M frame Πλαίσιο 3 θέσεων	 50-00423-23	 50-00423-26	 50-00423-18
4M frame Πλαίσιο 4 θέσεων	 50-00424-23	 50-00424-26	 50-00424-18
7M frame Πλαίσιο 7 θέσεων	 50-00427-23	 50-00427-26	 50-00427-18

design your house with  
new electric switches



## Multigang frames PVC Πλαίσια PVC

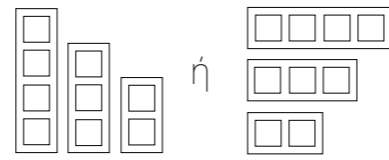









Horizontal or vertical | Coaxial distance 71mm

Οριζόντιας ή κάθετης τοποθέτησης | ομοαξονική απόσταση 71mm



### Basic

Color Χρώμα	White Λευκό	Black Μαύρο	Silver Ασημί
2gang frame Πλαίσιο διπλό	 50-02422-1	 50-02422-2	 50-02422-10
3gang frame Πλαίσιο 3πλό	 50-02423-1	 50-02423-2	 50-02423-10
4gang frame Πλαίσιο 4πλό	 50-02424-1	 50-02424-2	 50-02424-10

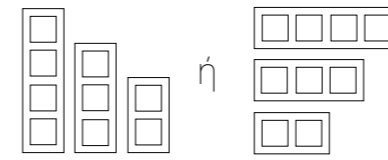









## Multigang frames glass & aluminum Πλαίσια γυάλινα & αλουμινίου









Horizontal or vertical | Coaxial distance 71mm

Οριζόντιας ή κάθετης τοποθέτησης | ομοαξονική απόσταση 71mm



Color Χρώμα	White Λευκό	Black Μαύρο	Silver Ασημί
2gang frame Πλαίσιο διπλό	 50-02422-23	 50-02422-26	 50-02422-18
3gang frame Πλαίσιο 3πλό	 50-02423-23	 50-02423-26	 50-02423-18
4gang frame Πλαίσιο 4πλό	 50-02424-23	 50-02424-26	 50-02424-18

### Elegant



Color Χρώμα	Wood Φυσικό δρυς	Champagne Σαμπανιζέ	Gold matte Χρυσό ματ
2gang frame Πλαίσιο διπλό	 50-02422-27	 50-02422-28	 50-02422-9
3gang frame Πλαίσιο 3πλό	 50-02423-27	 50-02423-28	 50-02423-9
4gang frame Πλαίσιο 4πλό	 50-02424-27	 50-02424-28	 50-02424-9



## Dimensions Διαστάσεις

### Multiple frames

Πλαίσια πολλαπλών θέσεων

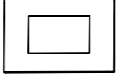
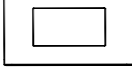
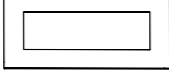
<b>1M frame</b> Πλαίσιο 1 θέσης	code/κωδ. 50-00420		88x88mm
<b>2M frame</b> Πλαίσιο 2 θέσεων	code/κωδ. 50-00421		88x88mm
<b>3M frame</b> Πλαίσιο 3 θέσεων	code/κωδ. 50-00423		12x88mm
<b>4M frame</b> Πλαίσιο 4 θέσεων	code/κωδ. 50-00424		145x88mm
<b>7M frame</b> Πλαίσιο 7 θέσεων	code/κωδ. 50-00427		203x88mm

PVC frame thickness / Πάχος πλαίσιο PVC : 7mm  
Glass, aluminium frame thickness / Πάχος πλαισίου γυαλί, αλουμίνιο : 9mm

### Multigang frames horizontal or vertical

Πλαίσια πολλαπλών θέσεων οριζόντιας ή κάθετης τοποθέτησης

<b>2gang frame</b> Πλαίσιο διπλό	code/κωδ. 50-02422		160x88mm
<b>3gang frame</b> Πλαίσιο 3πλό	code/κωδ. 50-02423		230x88mm
<b>4gang frame</b> Πλαίσιο 4πλό	code/κωδ. 50-02424		300x88mm

PVC frame thickness / Πάχος πλαίσιο PVC : 7mm  
Glass, aluminium frame thickness / Πάχος πλαισίου γυαλί, αλουμίνιο : 9mm



## Installation methods Μέθοδοι εγκατάστασης

Horizontal or vertical | Coaxial distance 71mm

Οριζόντιας ή κάθετης τοποθέτησης | ομοαξονική απόσταση 71mm

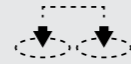

Composition Σύνθεση	Box Κουτί	Support frame Στήριγμα	Switch Διακόπτης	Frame Πλαίσιο
	Χωνευτή εγκατάσταση  για τοιχοποιία για γυψοσανίδες	  2πλό		
	Χωνευτή εγκατάσταση  για τοιχοποιία για γυψοσανίδες	  3πλό		
	Χωνευτή εγκατάσταση  για τοιχοποιία για γυψοσανίδες	  4πλό		

## Installation methods Μέθοδοι εγκατάστασης

Composition Σύνθεση	Box Κουτί	Support frame Στήριγμα	Switch Διακόπτης	Frame Πλαίσιο
	Χωνευτή εγκατάσταση  για τοιχοποιία για γυψοσανίδες	  1 στοιχείου		
	Χωνευτή εγκατάσταση  για τοιχοποιία για γυψοσανίδες	  2 στοιχείων	 ή 	
	Χωνευτή εγκατάσταση  για τοιχοποιία για γυψοσανίδες	  3 στοιχείων		
	Χωνευτή εγκατάσταση  για τοιχοποιία για γυψοσανίδες	  4 στοιχείων		
	Χωνευτή εγκατάσταση  για τοιχοποιία για γυψοσανίδες	  7 στοιχείων		

# H Series

## Flexible applications Ευέλικτες εφαρμογές

LINEME H-Series switching, provides a range of switches and sockets for all the applications and a variety of decorative frames in colors and materials even for the most adventurous of tastes. The unique design balances harmoniously in any environment of any style, and the high quality materials both create a perfect combination of aesthetics, reliability and safety.

Η σειρά διακοπτικού υλικού **LINEME H-Series**, διαθέτει μια γκάμα διακοπών και πριζών για όλες τις εφαρμογές, καθώς και μια ποικιλία διακοσμητικών πλαισίων με χρώματα και υλικά ακόμη και για τις πιο τολμηρές προτιμήσεις. Το μοναδικό design ισορροπεί αρμονικά σε κάθε χώρο ανεξαρτήτου ύφους και τα εξαιρετικής ποιότητας υλικά, δημιουργούν έναν απόλυτο συνδυασμό αισθητικής, αξιοπιστίας και ασφάλειας.



luxury lifestyle



# H Series

**Safety & reliability**  
Ασφάλεια & αξιοπιστία



For all the **LINEME products**, are used premium quality materials so that they meet all the safety requirements. The metal parts are manufactured of specially treated, fine quality metal, to achieve the maximum stability on the mounting surface. They are also covered with electrostatic paint for protection and durability. All the sockets mechanisms are equipped with protective copper power outlets, a double-holding system, normal hardness protective grounding clips and screw-tighten copper power supply terminals. On the switching and push button mechanisms with light is installed an LED signal bulb, for longer lifetime and energy saving.

Στα προϊόντα διακοπτικού υλικού **LINEME**, χρησιμοποιούνται υλικά άριστης ποιότητας, έτσι ώστε να πληρούν όλες τις προδιαγραφές ασφαλείας. Τα μεταλλικά μέρη είναι κατασκευασμένα από ειδικά κατεργασμένο μέταλλο υψηλής αντοχής, για απόλυτη στιβαρότητα και είναι βαμμένα με ηλεκτροστατική βαφή, για μέγιστη ανθεκτικότητα. Όλοι οι εξαιρετικής ποιότητας μηχανισμοί, διαθέτουν χάλκινες προστατευμένες επαφές ασφαλείας, διπλό σύστημα συγκράτησης, ελάσματα γείωσης ιδανικής σκληρότητας και χάλκινες βιδωτές επαφές παροχής ρεύματος. Στους μηχανισμούς διακόπτων με λυχνία χρησιμοποιείται λαμπτήρας LED για μεγαλύτερη διάρκεια ζωής και εξοικονόμηση ενέργειας.

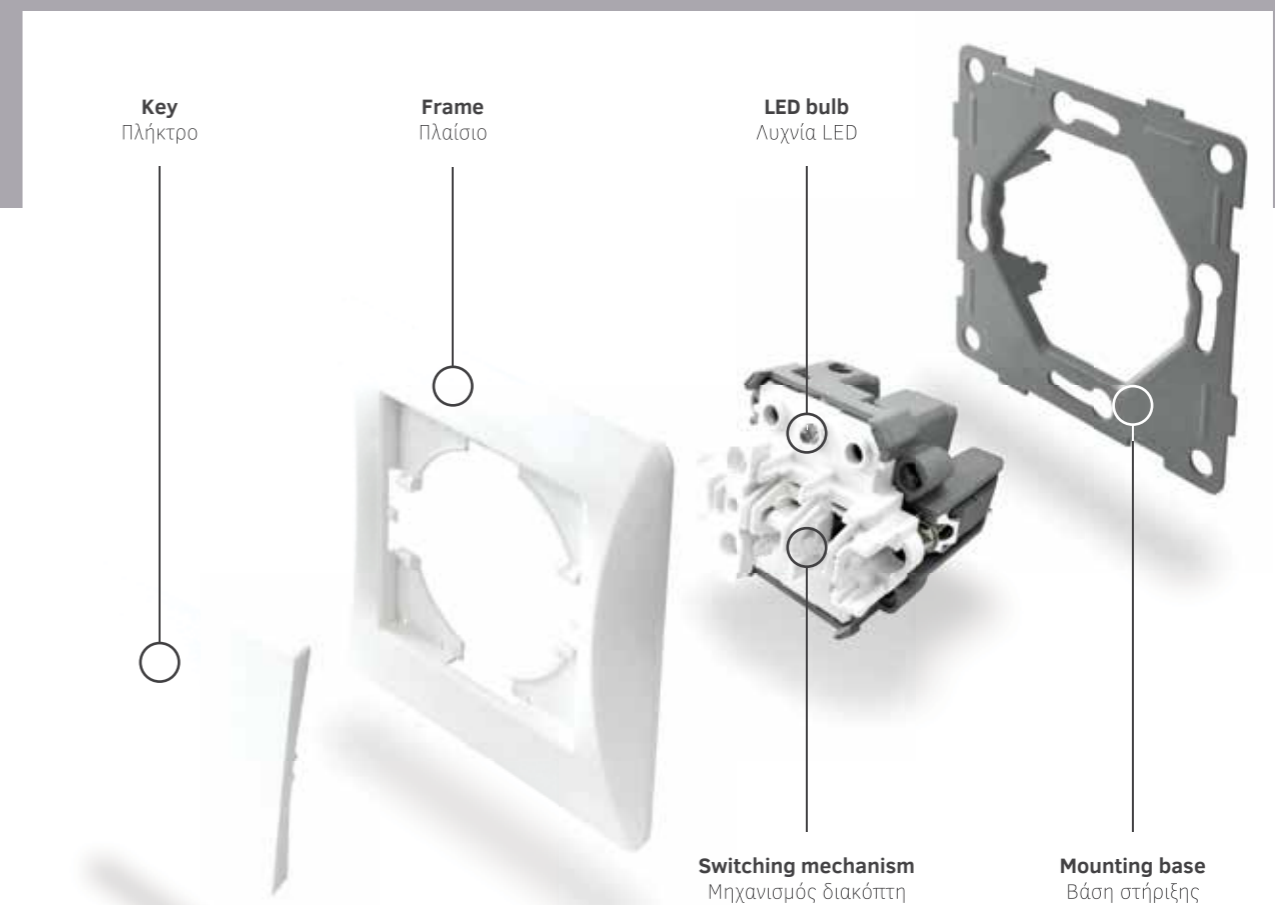
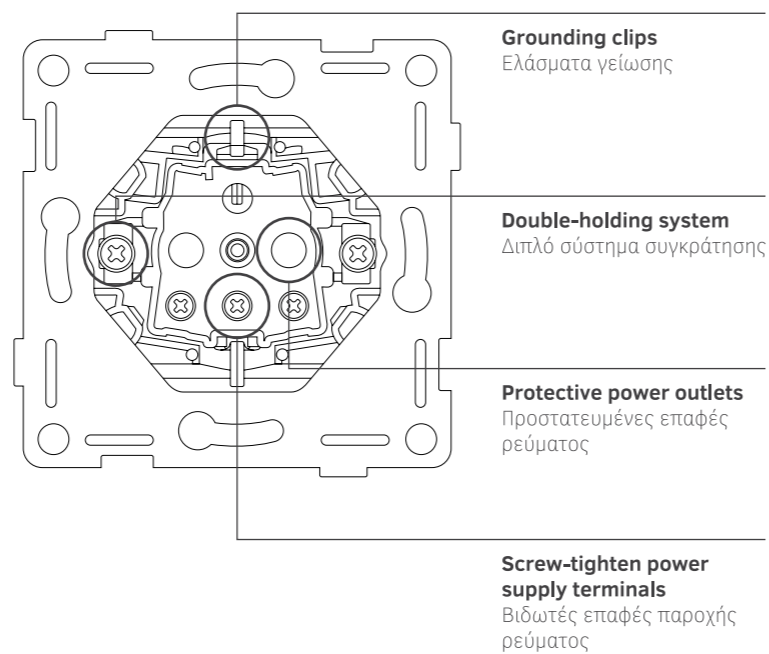

## Variety of functions Ποικιλία λειτουργιών

LINEME H-Series switching, provides a range of switches and sockets, for all the functions you can find in a residential or a professional environment.

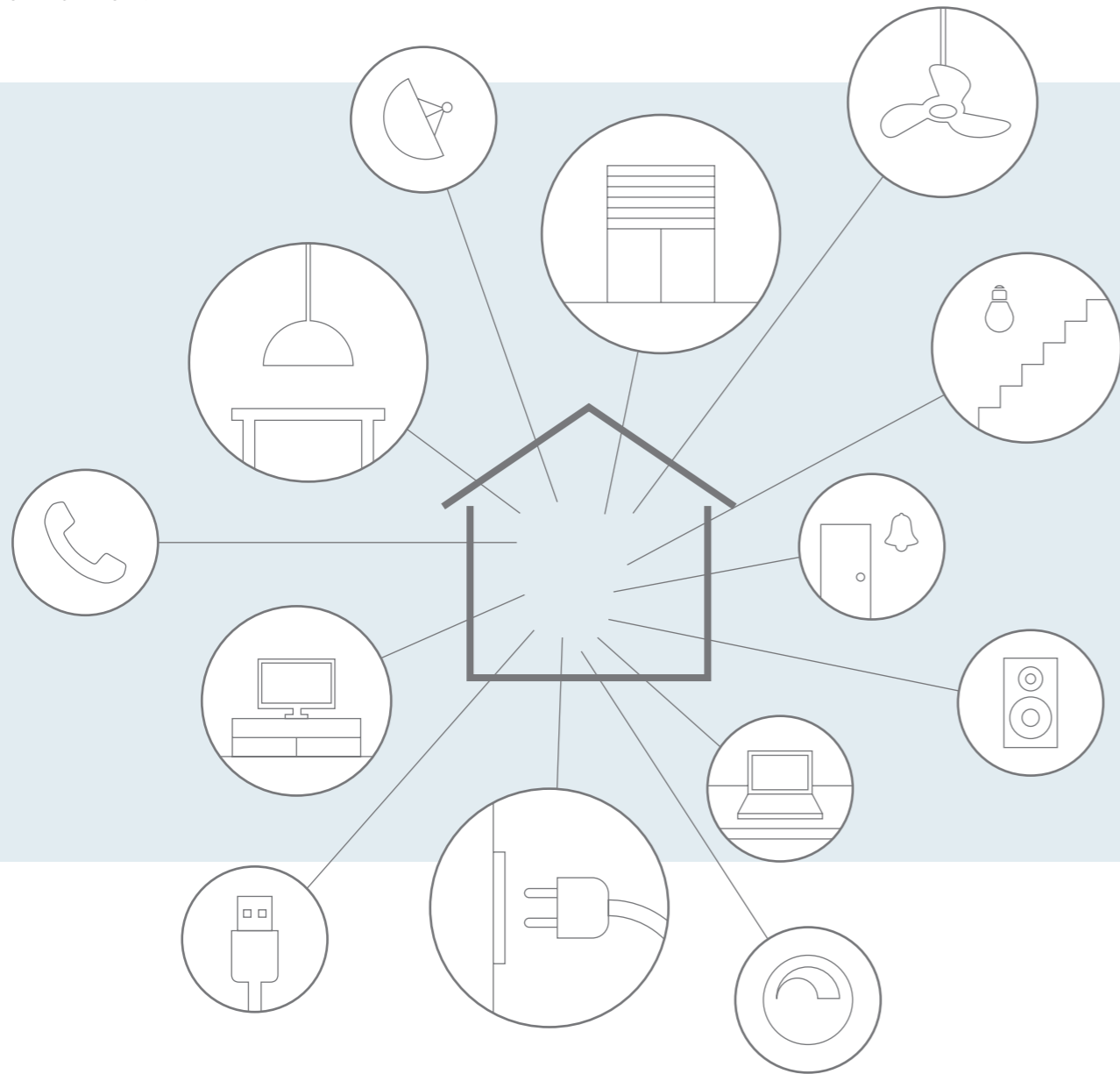

Η σειρά διακοπτικού υλικού LINEME H-Series, διαθέτει μία γκάμα διακοπών και πριζών, για όλες τις λειτουργίες που μπορείτε να βρείτε, σε ένα σπίτι και σε έναν επαγγελματικό χώρο.

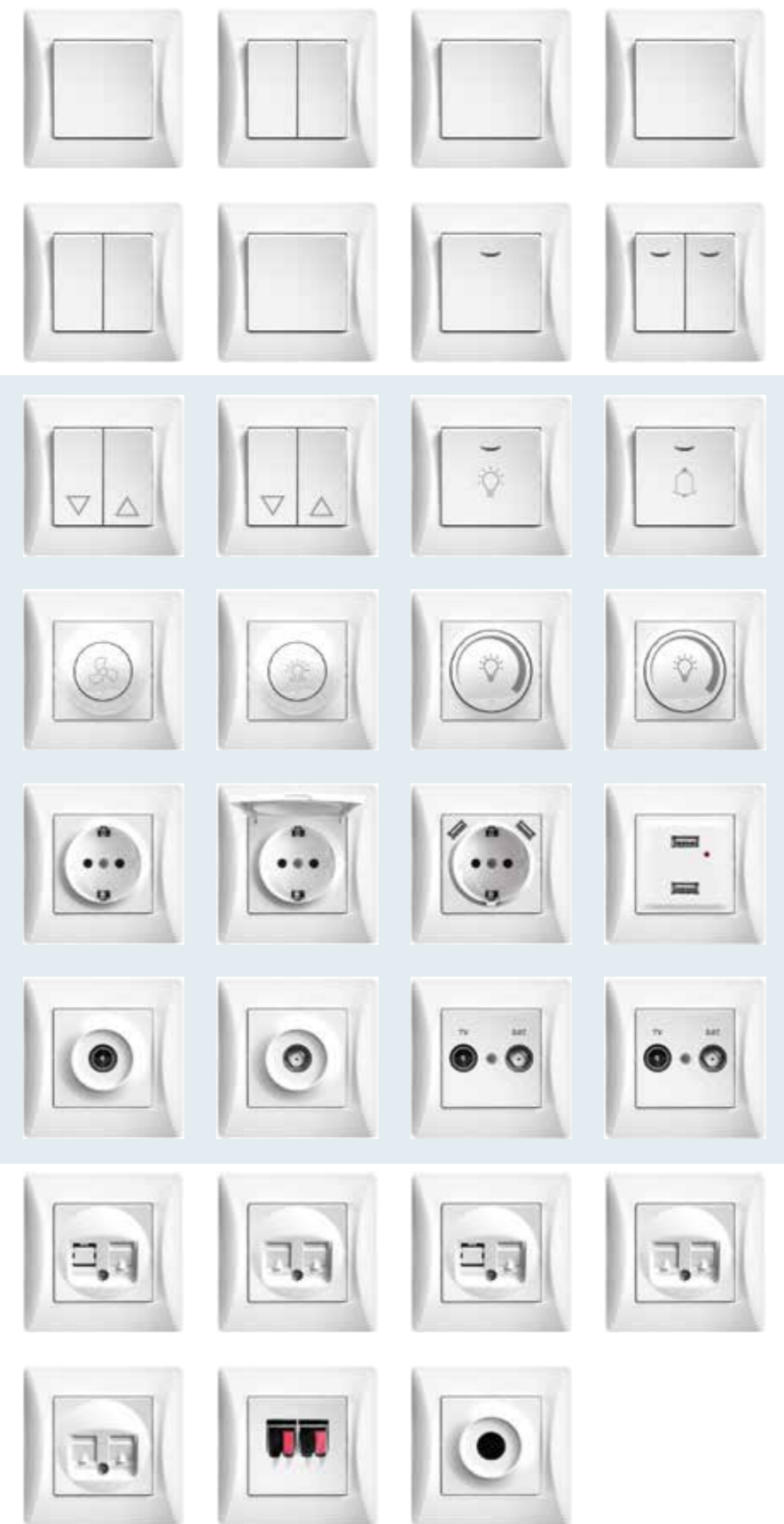



minimal chic

## Standard lighting switches Διακόπτες φωτισμού

**Single switch**  
Διακόπτης μονός



50-00101-1    50-00101-30    50-00101-2    50-00101-5    50-00101-9

2M 10A/250V  
Βάθος: 36mm  
Διάσταση: 85mmx85mm



**Single A/R switch**  
Διακόπτης μονός αλέρετου



50-00102-1    50-00102-30    50-00102-2    50-00102-5    50-00102-9

2M 10A/250V  
Βάθος: 36mm  
Διάσταση: 85mmx85mm



**Double switch**  
Διακόπτης κομτατέρ διπλός



50-00103-1    50-00103-30    50-00103-2    50-00103-5    50-00103-9

2M 10A/250V  
Βάθος: 36mm  
Διάσταση: 85mmx85mm

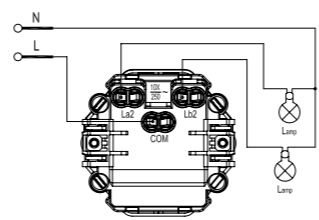

**Double A/R switch**  
Διακόπτης κομτατέρ αλέρετου διπλός



50-00104-1    50-00104-30    50-00104-2    50-00104-5    50-00104-9

2M 10A/250V  
Βάθος: 36mm  
Διάσταση: 85mmx85mm

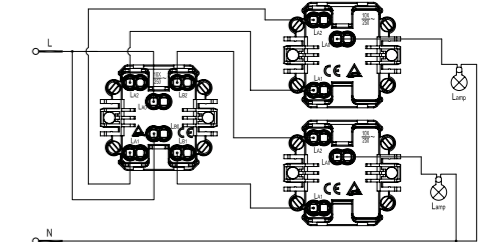

**Double pole single switch**  
Διακόπτης διπολικός μονός



50-00131-1    50-00131-30    50-00131-2    50-00131-5    50-00131-9

2M 10A/250V  
Βάθος: 36mm  
Διάσταση: 85mmx85mm

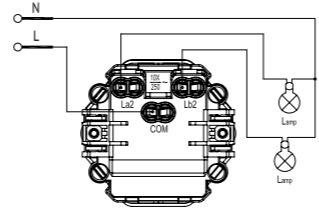

**Single intermediate A/R switch**  
Διακόπτης μεσαίος αλέρετου μονός



50-00132-1    50-00132-30    50-00132-2    50-00132-5    50-00132-9

2M 10A/250V  
Βάθος: 36mm  
Διάσταση: 85mmx85mm

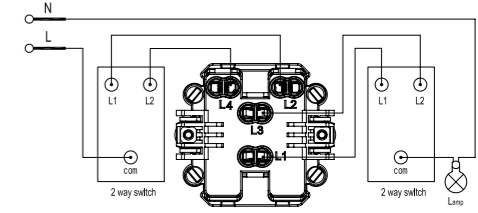

## A/R lighting switches with light

Διακόπτες φωτισμού αλέρετουρ με λυχνία



50-00105-1 50-00105-30 50-00105-2 50-00105-5 50-00105-9

2M 10A/250V  
Βάθος: 36mm  
Διάσταση: 85mmx85mm

### Single A/R switch with light

Διακόπτης μονός αλέρετουρ με λυχνία

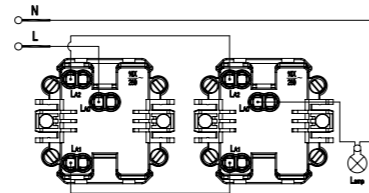

## Curtain switches & push buttons

Διακόπτες και μπουτόν ρολλών



50-00109-1 50-00109-30 50-00109-2 50-00109-5 50-00109-9

2M 10A/250V  
Βάθος: 36mm  
Διάσταση: 85mmx85mm

### Curtain switch

Διακόπτης ρολλών

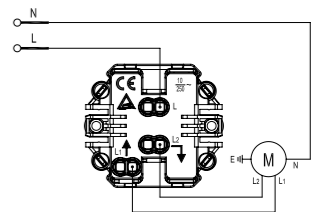

50-00106-1 50-00106-30 50-00106-2 50-00106-5 50-00106-9

2M 10A/250V  
Βάθος: 36mm  
Διάσταση: 85mmx85mm

### Double A/R switch with light

Διακόπτης κομιτατέρ αλέρετουρ με λυχνία (διπλός)

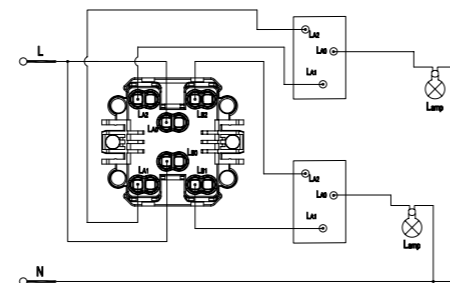

50-00136-1 50-00136-30 50-00136-2 50-00136-5 50-00136-9

2M 10A/250V  
Βάθος: 36mm  
Διάσταση: 85mmx85mm

### Curtain push button

Μπουτόν ρολλών

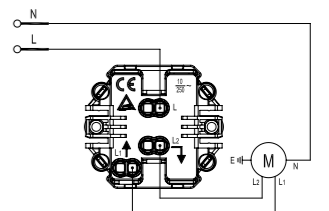

**Push buttons with light**  
Μπουτόν με λυχνία

**Single stairway push button with light**  
Μπουτόν κλιμακοστασίου με λυχνία

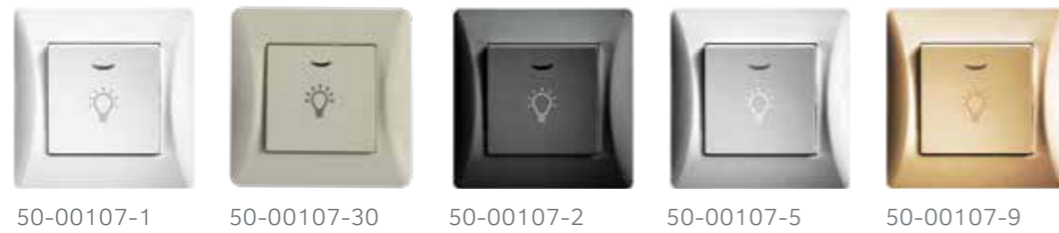

50-00107-1    50-00107-30    50-00107-2    50-00107-5    50-00107-9

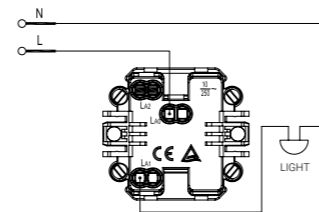

2M 220-240V  
Βάθος: 36mm  
Διάσταση: 85mmx85mm

**Door-bell push button with light**  
Μπουτόν κωδώνου με λυχνία



50-00108-1    50-00108-30    50-00108-2    50-00108-5    50-00108-9

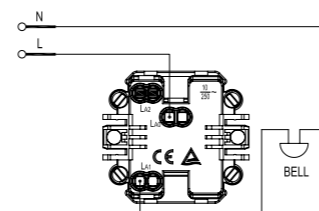

2M 10A/36V  
Βάθος: 36mm  
Διάσταση: 85mmx85mm





#betterlife

### Fan speed switches

Διακόπτες ταχύτητας ανεμιστήρα



50-00112-1    50-00112-30    50-00112-2    50-00112-5    50-00112-9

2M 10A/250V  
Βάθος: 36mm  
Διάσταση: 85mmx85mm

**Fan speed switch**  
Διακόπτης ταχύτητας ανεμιστήρα

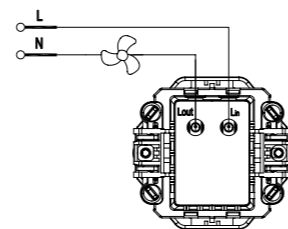

### Dimmer Ρεοστάτες

**Dimmer for LED light**  
Ρεοστάτης για λαμπτήρα LED



50-00111-1    50-00111-30    50-00111-2    50-00111-5    50-00111-9

2M 200W  
Βάθος: 36mm  
Διάσταση: 85mmx85mm

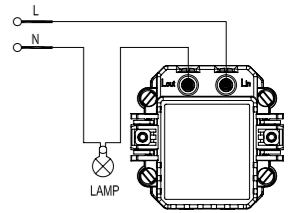

**Dimmer A/R for LED light**  
Ρεοστάτης A/R για λαμπτήρα LED



50-00141-1    50-00141-30    50-00141-2    50-00141-5    50-00141-9

2M 200W  
Βάθος: 36mm  
Διάσταση: 85mmx85mm

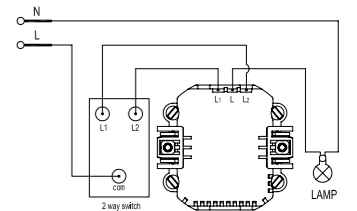

**Dimmer for ordinary light**  
Ρεοστάτης για απλό λαμπτήρα



50-00110-1    50-00110-30    50-00110-2    50-00110-5    50-00110-9

2M 500W  
Βάθος: 36mm  
Διάσταση: 85mmx85mm

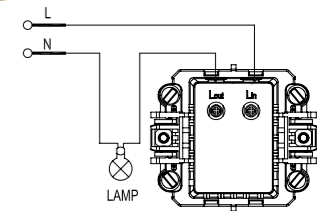

## Safety sockets Πρίζες ασφαλείας

## Safety sockets Πρίζες ασφαλείας

**Safety schuko socket**  
Πρίζα σούκο ασφαλείας



50-00113-1    50-00113-30    50-00113-2    50-00113-5    50-00113-9

2M 16A/250V  
Βάθος: 36mm  
Διάσταση: 85mmx85mm

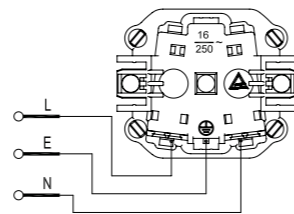

**Double USB port socket**  
Πρίζα USB διπλή



50-00139-1    50-00139-30    50-00139-2    50-00139-5    50-00139-9

Πρίζα USB Type A 5.1VDC/2.1A  
2 USB socket Type A 16A/250V 5.1VDC/2.1A

Βάθος: 36mm  
Διάσταση: 85mmx85mm

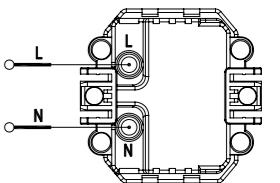

**Safety schuko socket with cover**  
Πρίζα σούκο ασφαλείας με καπάκι



50-00114-1    50-00114-30    50-00114-2    50-00114-5    50-00114-9

2M 16A/250V  
Βάθος: 36mm  
Διάσταση: 85mmx85mm

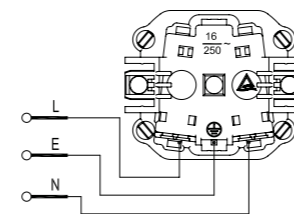

**Safety schuko socket with double USB port**  
Πρίζα σούκο ασφαλείας με 2 θύρες USB



50-00133-1    50-00133-30    50-00133-2    50-00133-5    50-00133-9

Πρίζα σούκο και 2 USB Type A κανονικής φόρτισης 16A/250V 5.1VDC/2.1A  
1 gang schuko & 2 USB socket Type A normal charging 16A/250V 5.1VDC/2.1A

Βάθος: 36mm  
Διάσταση: 85mmx85mm

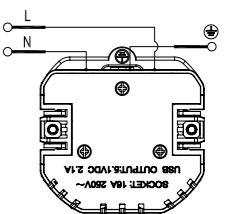

## TV & SAT sockets

Πρίζες τηλεόρασης & δορυφορικές

### Single TV socket

Πρίζα τηλεόρασης τερματική



50-00116-1    50-00116-30    50-00116-2    50-00116-5    50-00116-9

2M  
Βάθος: 36mm  
Διάσταση: 85mmx85mm

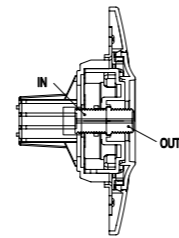

### Single SAT socket

Πρίζα δορυφορική τερματική



50-00117-1    50-00117-30    50-00117-2    50-00117-5    50-00117-9

2M  
Βάθος: 36mm  
Διάσταση: 85mmx85mm

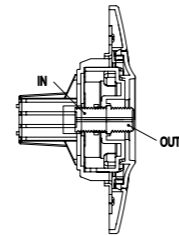

## TV & SAT sockets

Πρίζες τηλεόρασης & δορυφορικές

### Intermediate TV-SAT socket

Πρίζα τηλεόρασης & δορυφορική διελεύσεως



50-00134-1    50-00134-30    50-00134-2    50-00134-5    50-00134-9

2M  
Απορρόφηση κατανομής 10dB  
Βάθος: 36mm  
Διάσταση: 85mmx85mm

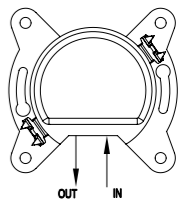

### Terminal TV-SAT socket

Πρίζα τηλεόρασης & δορυφορική τερματική



50-00138-1    50-00138-30    50-00138-2    50-00138-5    50-00138-9

2M  
Απορρόφηση κατανομής 3.5dB  
Βάθος: 36mm  
Διάσταση: 85mmx85mm

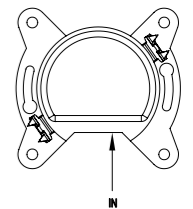

## Telephone sockets Πρίζες τηλεφώνου

perfection  
is our motto

### Single RJ11 telephone socket Πρίζα RJ11 τηλεφώνου μονή



50-00115-1 50-00115-30 50-00115-2 50-00115-5 50-00115-9

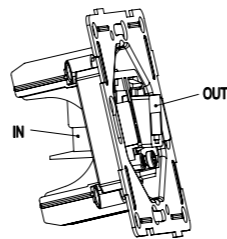

2M  
Βάθος: 36mm  
Διάσταση: 85mmx85mm

### Double RJ11 telephone socket Πρίζα RJ11 τηλεφώνου διπλή



50-00119-1 50-00119-30 50-00119-2 50-00119-5 50-00119-9

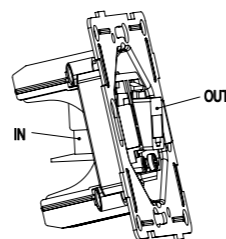

2M  
Βάθος: 36mm  
Διάσταση: 85mmx85mm

## Telephone sockets Πρίζες τηλεφώνου

### Single RJ45 data socket CAT6 Πρίζα RJ45 δεδομένων CAT6 μονή



50-00118-1 50-00118-30 50-00118-2 50-00118-5 50-00118-9

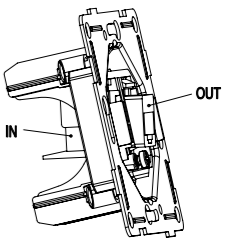

2M  
Βάθος: 36mm  
Διάσταση: 85mmx85mm

### Double RJ45 data socket CAT6 Πρίζα RJ45 δεδομένων CAT6 διπλή



50-00130-1 50-00130-30 50-00130-2 50-00130-5 50-00130-9

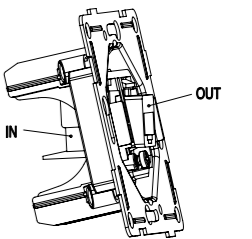

2M  
Βάθος: 36mm  
Διάσταση: 85mmx85mm

### RJ11 telephone & RJ45 data socket CAT6 Πρίζα RJ11 τηλεφώνου & RJ45 δεδομένων CAT6



50-00120-1 50-00120-30 50-00120-2 50-00120-5 50-00120-9

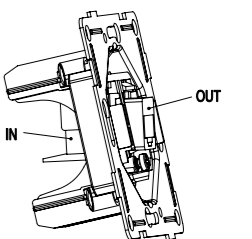

2M  
Βάθος: 36mm  
Διάσταση: 85mmx85mm

## Sound sockets Πρίζες ήχου

**Double loud speaker socket**  
Πρίζα ηχείων διπλή



50-00135-1    50-00135-30    50-00135-2    50-00135-5    50-00135-9

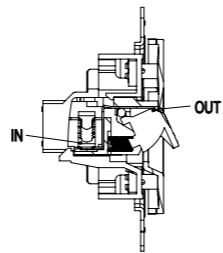

2M  
Βάθος: 36mm  
Διάσταση: 85mmx85mm

**Cable outlet plate**  
Πλάκα εξόδου καλωδίων



50-00137-1    50-00137-30    50-00137-2    50-00137-5    50-00137-9

2M  
Βάθος: 36mm  
Διάσταση: 85mmx85mm

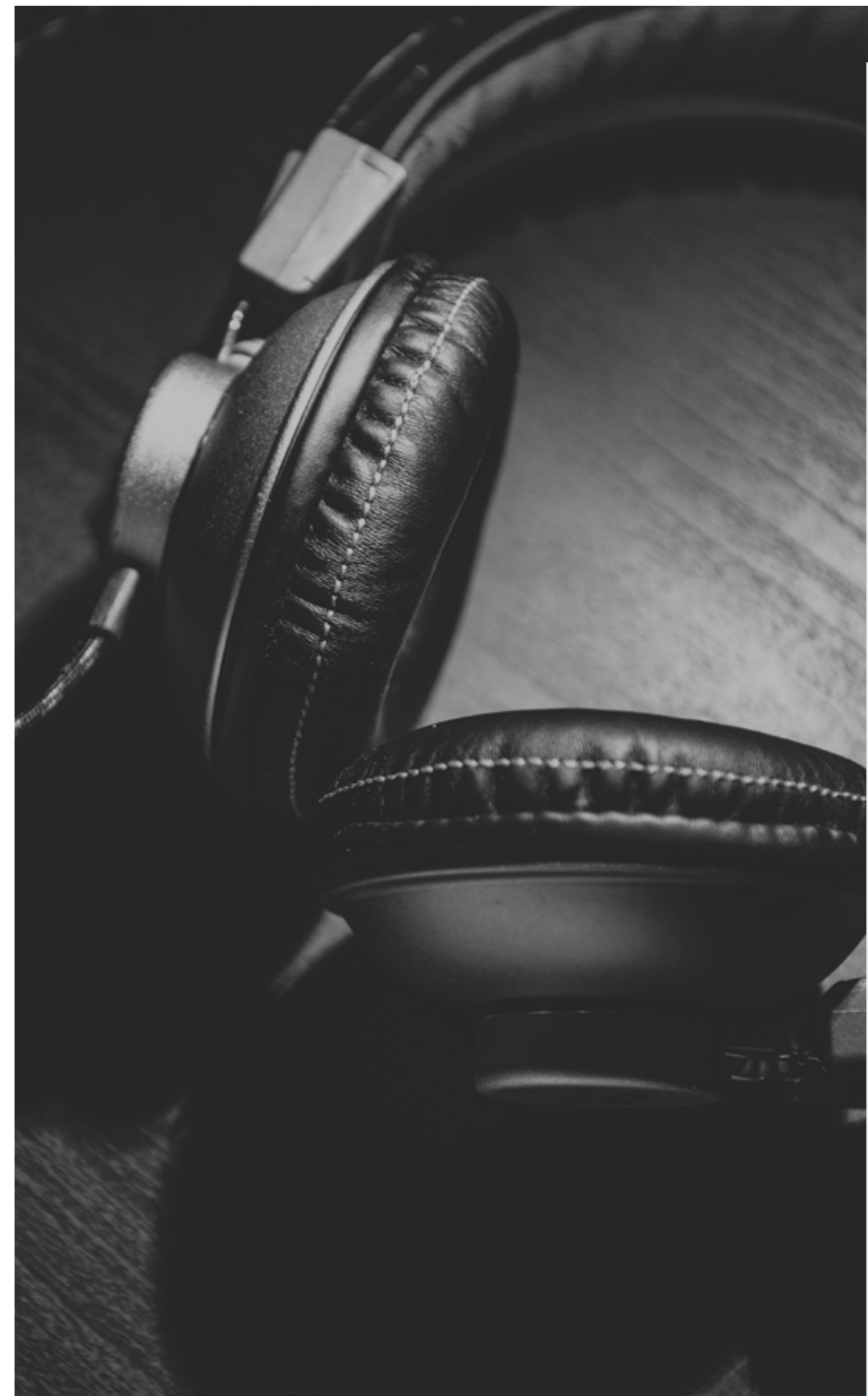



## Multiple frames PVC Πλαίσια πολλαπλών θέσεων PVC

Ομοαξονική απόσταση 71mm 











Πάχος: 8mm

**Required only in case of replacement of the original frame of the socket-switch**  
Απαιτούνται μόνο στην περίπτωση αντικατάστασης του αρχικού πλαισίου του διακόπτη-πρίζας













Color Χρώμα  **White**  
Λευκό  **Ivory**  
Ιβουάρ  **Black**  
Μαύρο

single frame Πλαίσιο μονό	 50-00121-1	 50-00121-30	 50-00121-2
---------------------------------	---	--	---

**Horizontal**  
Οριζόντια

2gang frame Πλαίσιο 2πλό	 50-00122-1	 50-00122-30	 50-00122-2
3gang frame Πλαίσιο 3πλό	 50-00123-1	 50-00123-30	 50-00123-2
4gang frame Πλαίσιο 4πλό	 50-00124-1	 50-00124-30	 50-00124-2
5gang frame Πλαίσιο 5πλό	 50-00125-1	 50-00125-30	 50-00125-2

**Vertical**  
Κάθετα

2gang frame Πλαίσιο 2πλό	3gang frame Πλαίσιο 3πλό	4gang frame Πλαίσιο 4πλό	5gang frame Πλαίσιο 5πλό	2gang frame Πλαίσιο 2πλό	3gang frame Πλαίσιο 3πλό	4gang frame Πλαίσιο 4πλό	5gang frame Πλαίσιο 5πλό	2gang frame Πλαίσιο 2πλό	3gang frame Πλαίσιο 3πλό	4gang frame Πλαίσιο 4πλό	5gang frame Πλαίσιο 5πλό
 50-00126-1	 50-00127-1	 50-00128-1	 50-00129-1	 50-00126-30	 50-00127-30	 50-00128-30	 50-00129-30	 50-00126-2	 50-00127-2	 50-00128-2	 50-00129-2

Ομοαξονική απόσταση 71mm 

Πάχος: 8mm









## Multiple frames PVC Πλαίσια πολλαπλών θέσεων PVC

**Required only in case of replacement of the original frame of the socket-switch**  
Απαιτούνται μόνο στην περίπτωση αντικατάστασης του αρχικού πλαισίου του διακόπτη-πρίζας









Color Χρώμα  **Silver**  
Ασημί  **Gold**  
Χρυσό

single frame Πλαίσιο μονό	 50-00121-5	 50-00121-9
---------------------------------	---	---

**Horizontal**  
Οριζόντια

2gang frame Πλαίσιο 2πλό	 50-00122-5	 50-00122-9
3gang frame Πλαίσιο 3πλό	 50-00123-5	 50-00123-9
4gang frame Πλαίσιο 4πλό	 50-00124-5	 50-00124-9
5gang frame Πλαίσιο 5πλό	 50-00125-5	 50-00125-9

**Vertical**  
Κάθετα



2gang frame Πλαίσιο 2πλό	3gang frame Πλαίσιο 3πλό	4gang frame Πλαίσιο 4πλό	5gang frame Πλαίσιο 5πλό	2gang frame Πλαίσιο 2πλό	3gang frame Πλαίσιο 3πλό	4gang frame Πλαίσιο 4πλό	5gang frame Πλαίσιο 5πλό
 50-00126-5	 50-00127-5	 50-00128-5	 50-00129-5	 50-00126-9	 50-00127-9	 50-00128-9	 50-00129-9

## Multiple frames PVC Πλαίσια πολλαπλών θέσεων PVC

Ομοαξονική απόσταση 71mm 

**Required only in case of replacement of the original frame of the socket-switch**  
Απαιτούνται μόνο στην περίπτωση αντικατάστασης του αρχικού πλαισίου του διακόπτη-πρίζας











Color Χρώμα  **White** Λευκό  **Black** Μαύρο  **Aqua** Βεραμάν

single frame Πλαίσιο μονό	 50-00121-23	 50-00121-26	 50-00121-24
---------------------------------	--	--	--

**Horizontal**  
Οριζόντια

2gang frame Πλαίσιο 2πλό	 50-00122-23	 50-00122-26	 50-00122-24
3gang frame Πλαίσιο 3πλό	 50-00123-23	 50-00123-26	 50-00123-24
4gang frame Πλαίσιο 4πλό	 50-00124-23	 50-00124-26	
5gang frame Πλαίσιο 5πλό	 50-00125-23	 50-00125-26	

**Vertical**  
Κάθετα



	2gang frame Πλαίσιο 2πλό	3gang frame Πλαίσιο 3πλό	4gang frame Πλαίσιο 4πλό	5gang frame Πλαίσιο 5πλό	2gang frame Πλαίσιο 2πλό	3gang frame Πλαίσιο 3πλό	4gang frame Πλαίσιο 4πλό	5gang frame Πλαίσιο 5πλό	2gang frame Πλαίσιο 2πλό	3gang frame Πλαίσιο 3πλό
	 50-00126-23	 50-00127-23	 50-00128-23	 50-00129-23	 50-00126-26	 50-00127-26	 50-00128-26	 50-00129-26	 50-00126-24	 50-00127-24

## Multiple frames PVC Πλαίσια πολλαπλών θέσεων PVC



Ομοαξονική απόσταση 71mm 

**Required only in case of replacement of the original frame of the socket-switch**  
Απαιτούνται μόνο στην περίπτωση αντικατάστασης του αρχικού πλαισίου του διακόπτη-πρίζας





Color Χρώμα  **Silver** Ασημί  **Champagne** Σαμπανιζέ  **Gold** Χρυσό

single frame Πλαίσιο μονό	 50-00121-18	 50-00121-25	 50-00121-6
---------------------------------	--	--	---

**Horizontal**  
Οριζόντια

2gang frame Πλαίσιο 2πλό	 50-00122-18	 50-00122-25	 50-00122-6
3gang frame Πλαίσιο 3πλό	 50-00123-18	 50-00123-25	 50-00123-6

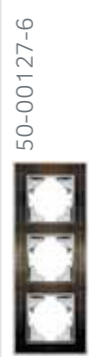

**Vertical**  
Κάθετα

	2gang frame Πλαίσιο 2πλό	3gang frame Πλαίσιο 3πλό	2gang frame Πλαίσιο 2πλό	3gang frame Πλαίσιο 3πλό	2gang frame Πλαίσιο 2πλό	3gang frame Πλαίσιο 3πλό
	 50-00126-18	 50-00127-18	 50-00126-25	 50-00127-25	 50-00126-6	 50-00127-6

## Dimensions Διαστάσεις

### Horizontal multiple frames

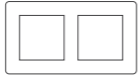

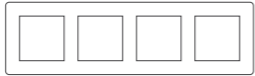
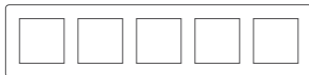
Πλαίσια πολλαπλών θέσεων οριζόντια

<b>Single frame</b> Πλαίσιο μονό	code/κωδ. 50-00121		85x85mm
<b>2 gang horizontal frame</b> Πλαίσιο οριζόντιο διπλό	code/κωδ. 50-00122		155x85mm
<b>3 gang horizontal frame</b> Πλαίσιο οριζόντιο τριπλό	code/κωδ. 50-00123		228x85mm
<b>4 gang horizontal frame</b> Πλαίσιο οριζόντιο τετραπλό	code/κωδ. 50-00124		300x85mm
<b>5 gang horizontal frame</b> Πλαίσιο οριζόντιο πενταπλό	code/κωδ. 50-00125		370x85mm

Frame thickness / Πάχος πλαισίου : 8mm

### Vertical multiple frames

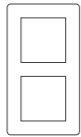
Πλαίσια πολλαπλών θέσεων κάθετα

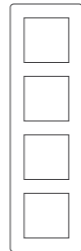
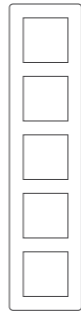
Single frame Πλαίσιο μονό	2gang frame Πλαίσιο 2πλό	3gang frame Πλαίσιο 3πλό	4gang frame Πλαίσιο 4πλό	5gang frame Πλαίσιο 5πλό
code/κωδ. 50-00121	code/κωδ. 50-00126	code/κωδ. 50-00127	code/κωδ. 50-00128	code/κωδ. 50-00129
				
85x85mm	85x155mm	85x228mm	85x300mm	85x370mm

Frame thickness / Πάχος πλαισίου : 8mm



# S Series

**Wall mount switches IP20**  
Εξωτερικοί διακόπτες IP20



keep it simple



## Wall mount switches IP20

Διακόπτες εξωτερικού χώρου IP20



50-00300-1 50-00300-2

2M 10A  
Βάθος: 36mm  
Διάσταση: 68mmx68mm

**Push button**  
Μπουτόν μονό

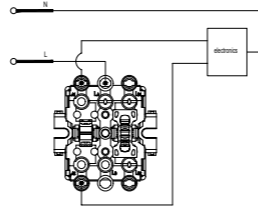

50-00302-1 50-00302-2

2M 10A  
Βάθος: 36mm  
Διάσταση: 68mmx68mm

**Single A/R switch**  
Διακόπτης αλέρετουρ μονός

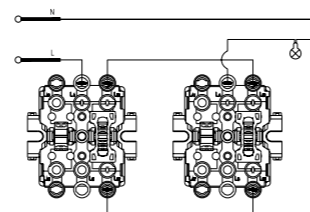

50-00303-1 50-00303-2

2M 10A  
Βάθος: 36mm  
Διάσταση: 68mmx68mm

**Double push button**  
Μπουτόν διπλό

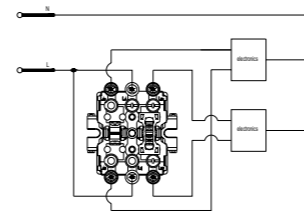

50-00304-1 50-00304-2

2M 10A  
Βάθος: 36mm  
Διάσταση: 68mmx68mm

**Double A/R switch**  
Διακόπτης αλέρετουρ διπλός

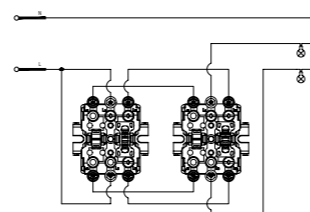

## Wall mount sockets IP20

Πρίζες εξωτερικού χώρου IP20



50-00313-1 50-00313-2

2M 16A  
Βάθος: 42mm  
Διάσταση: 68mmx68mm

**Schuko socket**  
Πρίζα σούκο ασφαλείας

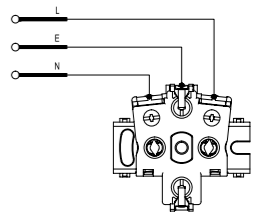

50-00315-1 50-00315-2

2M  
Βάθος: 42mm  
Διάσταση: 68mmx68mm

**Single RJ11 telephone socket**  
Πρίζα RJ11 τηλεφώνου μονή

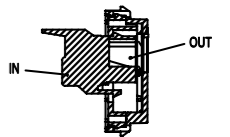

50-00316-1 50-00316-2

2M  
Βάθος: 42mm  
Διάσταση: 68mmx68mm

**Terminal TV-SAT socket**  
Πρίζα TV τερματική

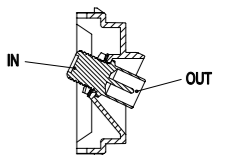

50-00318-1 50-00318-2

2M  
Βάθος: 42mm  
Διάσταση: 68mmx68mm

**RJ45 DATA socket CAT6**  
Πρίζα RJ45 δεδομένων CAT6

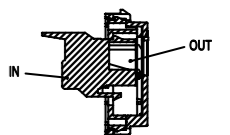

Registration numbers are available for all the power sockets  
Διατίθενται αριθμοί καταχώρησης για όλους τους ρευματοδότες-ρευματολήπτες που απαιτείται

ΕΥΡΕΤΗΡΙΟ/

Κωδικός	Σελίδα	Κωδικός	Σελίδα	Κωδικός	Σελίδα
50-00101-1	50	50-00108-5	54	50-00116-2	60
50-00101-2	50	50-00108-9	54	50-00116-30	60
50-00101-30	50	50-00109-1	53	50-00116-5	60
50-00101-5	50	50-00109-2	53	50-00116-9	60
50-00101-9	50	50-00109-30	53	50-00117-1	60
50-00102-1	51	50-00109-5	53	50-00117-2	60
50-00102-2	51	50-00109-9	53	50-00117-30	60
50-00102-30	51	50-00110-1	57	50-00117-5	60
50-00102-5	51	50-00110-2	57	50-00117-9	60
50-00102-9	51	50-00110-30	57	50-00118-1	63
50-00103-1	50	50-00110-5	57	50-00118-2	63
50-00103-2	50	50-00110-9	57	50-00118-30	63
50-00103-30	50	50-00111-1	57	50-00118-5	63
50-00103-5	50	50-00111-2	57	50-00118-9	63
50-00103-9	50	50-00111-30	57	50-00119-1	62
50-00104-1	51	50-00111-5	57	50-00119-2	62
50-00104-2	51	50-00111-9	57	50-00119-30	62
50-00104-30	51	50-00112-1	56	50-00119-5	62
50-00104-5	51	50-00112-2	56	50-00119-9	62
50-00104-9	51	50-00112-30	56	50-00120-1	63
50-00105-1	52	50-00112-5	56	50-00120-2	63
50-00105-2	52	50-00112-9	56	50-00120-30	63
50-00105-30	52	50-00113-1	58	50-00120-5	63
50-00105-5	52	50-00113-2	58	50-00120-9	63
50-00105-9	52	50-00113-30	58	50-00121-1	66
50-00106-1	52	50-00113-5	58	50-00121-18	69
50-00106-2	52	50-00113-9	58	50-00121-2	66
50-00106-30	52	50-00114-1	58	50-00121-23	68
50-00106-5	52	50-00114-2	58	50-00121-24	68
50-00106-9	52	50-00114-30	58	50-00121-25	69
50-00107-1	54	50-00114-5	58	50-00121-26	68
50-00107-2	54	50-00114-9	58	50-00121-30	66
50-00107-30	54	50-00115-1	62	50-00121-5	67
50-00107-5	54	50-00115-2	62	50-00121-9	67
50-00107-9	54	50-00115-30	62	50-00122-1	66
50-00108-1	54	50-00115-5	62	50-00122-18	69
50-00108-2	54	50-00115-9	62	50-00122-2	66
50-00108-30	54	50-00116-1	60	50-00122-2	69

ΕΥΡΕΤΗΡΙΟ/

Κωδικός	Σελίδα	Κωδικός	Σελίδα	Κωδικός	Σελίδα
50-00122-23	68	50-00127-23	68	50-00133-2	59
50-00122-25	69	50-00127-24	68	50-00133-30	59
50-00122-30	66	50-00127-25	69	50-00133-5	59
50-00122-5	67	50-00127-26	68	50-00133-9	59
50-00122-9	67	50-00127-30	66	50-00134-1	61
50-00123-18	69	50-00127-5	67	50-00134-2	61
50-00123-2	69	50-00127-6	69	50-00134-30	61
50-00123-24	70	50-00127-9	67	50-00134-5	61
50-00123-25	69	50-00128-1	66	50-00134-9	61
50-00123-26	68	50-00128-2	66	50-00135-1	64
50-00123-5	67	50-00128-23	68	50-00135-2	64
50-00123-9	67	50-00128-26	68	50-00135-30	64
50-00124-1	66	50-00128-30	66	50-00135-5	64
50-00124-2	66	50-00128-5	67	50-00135-9	64
50-00124-23	68	50-00128-9	67	50-00136-1	53
50-00124-26	68	50-00129-1	66	50-00136-2	53
50-00124-30	66	50-00129-2	66	50-00136-30	53
50-00125-1	66	50-00129-23	68	50-00136-5	53
50-00125-2	66	50-00129-26	68	50-00136-9	53
50-00125-23	68	50-00129-30	66	50-00137-1	64
50-00125-26	68	50-00129-5	67	50-00137-2	64
50-00125-30	66	50-00129-9	67	50-00137-30	64
50-00125-5	67	50-00130-1	63	50-00137-5	64
50-00125-9	67	50-00130-2	63	50-00137-9	64
50-00126-1	66	50-00130-30	63	50-00138-1	61
50-00126-18	69	50-00130-5	63	50-00138-2	61
50-00126-2	66	50-00130-9	63	50-00138-30	61
50-00126-23	68	50-00131-1	50	50-00138-5	61
50-00126-24	66	50-00131-2	50	50-00138-9	61
50-00126-25	67	50-00131-30	50	50-00139-1	59
50-00126-26	68	50-00131-5	50	50-00139-2	59
50-00126-30	66	50-00131-9	50	50-00139-30	59
50-00126-5	67	50-00132-1	51	50-00139-5	59
50-00126-6	69	50-00132-2	51	50-00139-9	59
50-00126-9	67	50-00132-30	51	50-00141-1	57
50-00127-1	66	50-00132-5	51	50-00141-2	57
50-00127-18	69	50-00132-9	51	50-00141-30	57
50-00127-2	66	50-00133-1	59	50-00141-5	57

## ΕΥΡΕΤΗΡΙΟ/

Κωδικός	Σελίδα	Κωδικός	Σελίδα	Κωδικός	Σελίδα
50-00141-9	57	50-00413-2	24	50-00423-26	34
50-00300-1	74	50-00414-1	24	50-00423-27	33
50-00300-2	74	50-00414-10	24	50-00423-28	33
50-00302-1	74	50-00414-2	24	50-00424-1	35
50-00302-2	74	50-00415-1	27	50-00424-2	32
50-00303-1	74	50-00415-10	27	50-00424-9	33
50-00303-2	74	50-00415-2	27	50-00424-10	32
50-00304-1	74	50-00416-1	26	50-00424-18	34
50-00304-2	74	50-00416-10	26	50-00424-23	34
50-00313-1	75	50-00416-2	26	50-00424-26	34
50-00313-2	75	50-00417-1	26	50-00424-27	33
50-00315-1	75	50-00417-10	26	50-00424-28	33
50-00315-2	75	50-00417-2	26	50-00427-1	32
50-00316-1	75	50-00418	27	50-00427-2	32
50-00316-2	75	50-00418-1	27	50-00427-9	33
50-00318-1	75	50-00418-10	27	50-00427-10	32
50-00318-2	75	50-00418-2	27	50-00427-18	34
50-00400-1	15	50-00420-1	32	50-00427-23	34
50-00400-2	15	50-00420-2	32	50-00427-26	34
50-00400-10	15	50-00420-9	33	50-00427-27	33
50-00401-1	12	50-00420-10	32	50-00427-28	33
50-00401-10	12	50-00420-27	33	50-00431-1	13
50-00401-2	12	50-00420-28	33	50-00432-1	13
50-00402-1	12	50-00421-1	34	50-00432-10	13
50-00402-10	12	50-00421-2	34	50-00432-2	15
50-00402-2	12	50-00421-9	33	50-00435-1	28
50-00410-1	18	50-00421-10	32	50-00435-10	28
50-00410-10	18	50-00421-18	34	50-00435-2	28
50-00410-2	18	50-00421-23	34	50-00436-1	16
50-00411-1	18	50-00421-26	34	50-00436-10	16
50-00411-10	18	50-00421-27	33	50-00436-2	16
50-00411-2	18	50-00421-28	33	50-00439-1	25
50-00412-1	18	50-00423-1	32	50-00439-10	25
50-00412-10	18	50-00423-2	32	50-00439-2	25
50-00412-2	18	50-00423-9	33	50-00440-1	22
50-00413-1	24	50-00423-10	32	50-00440-10	22
50-00413-10	24	50-00423-18	34	50-00440-2	22
50-00413-14	24	50-00423-23	34	50-00442-1	26

## ΕΥΡΕΤΗΡΙΟ/

Κωδικός	Σελίδα	Κωδικός	Σελίδα	Κωδικός	Σελίδα
50-00442-10	26	50-01401	31	50-02424-27	36
50-00442-2	26	50-01903	30	50-02424-28	36
50-00444-1	25	50-01904	30	50-02424-9	36
50-00444-10	25	50-01907	30	50-02431-1	13
50-00444-2	25	50-02401-1	12	50-02432-1	13
50-00446-1	14	50-02401-10	12	50-02432-10	13
50-00446-10	14	50-02401-2	12	50-02432-2	13
50-00446-2	14	50-02402-1	12	50-02439-1	25
50-00450-1	15	50-02402-10	12	50-02439-10	25
50-00450-10	15	50-02402-2	12	50-02439-2	25
50-00450-2	15	50-02408-1	17	50-02445-1	17
50-00451-1	15	50-02408-10	17	50-02445-10	17
50-00451-10	15	50-02408-2	17	50-02445-2	17
50-00451-2	15	50-02422-1	36	50-02446-1	14
50-00452-1	28	50-02422-10	36	50-02446-10	14
50-00452-10	28	50-02422-18	37	50-02446-2	14
50-00452-2	28	50-02422-2	36	50-02447-1	19
50-00453-1	14	50-02422-23	37	50-02447-10	19
50-00453-10	14	50-02422-26	37	50-02447-2	19
50-00453-2	14	50-02422-27	36	50-03455-1	23
50-00454-1	16	50-02422-28	36	50-03455-10	23
50-00454-10	16	50-02422-9	36	50-03455-2	23
50-00454-2	16	50-02423-1	36	50-13443-1	20
50-00455	23	50-02423-10	36	50-13443-10	20
50-00456	23	50-02423-18	37	50-13443-2	20
50-00900	21	50-02423-2	36	50-14443-1	21
50-00903	30	50-02423-23	37	50-14443-10	21
50-00904	30	50-02423-26	37	50-14443-2	21
50-00907	30	50-02423-27	36	50-30443-1	20
50-00930	22	50-02423-28	36	50-30443-10	20
50-00931	22	50-02423-9	36	50-30443-2	20
50-00932	23	50-02424-1	36	50-43456-1	19
50-00933	23	50-02424-10	36	50-43456-10	19
50-01400-1	31	50-02424-18	37	50-43456-2	19
50-01400-3	31	50-02424-2	36	50-60443-1	20
50-01400-4	31	50-02424-23	37	50-60443-10	20
50-01400-7	31	50-02424-26	37	50-60443-2	20

NOTES / ΣΗΜΕΙΩΣΕΙΣ

---

Lined writing area for page 80, featuring horizontal dotted lines for text entry.

NOTES / ΣΗΜΕΙΩΣΕΙΣ

---

Lined writing area for page 81, featuring horizontal dotted lines for text entry.



**LINEME**<sup>®</sup>  
S W I T C H I N G

switch your life

# H-Series INO-Series S-Series

Τεχνικός κατάλογος / Technical catalogue

